

The New Range of
**DISTRIBUTION
BOARDS**



About L&T

Larsen & Toubro is a technology, engineering, construction, manufacturing and services company with global operations. Strong customer-orientation, an innovative spirit and the constant quest for top-class quality have enabled L&T to attain and sustain leadership in its major lines of business for over seven decades.

L&T has set several global benchmarks of scale, speed and complexity in the projects it executes and the wide range of products it manufactures. With offerings that impact infrastructure development, hydrocarbon, power, aerospace and defence, the Company is seen in the role of nation-builder.

Internationally, L&T has a wide presence with manufacturing footprint that straddles eight countries, offices around the globe and collaborations with multiple global majors.



L&T is India's largest manufacturer of low tension switchgear. A wide range of products that suit specific needs of diverse industries, superior quality and a strong customer focused approach are reasons for the Company's leadership position over the years.

Products and solutions that enhance the safety of your homes and businesses through insulation and fire protection, cost saving due to lowering power consumption and flexibility are just a few of the advantages you gain.

In addition, you get the benefit of easy and quick availability through a wide network of more than 700 stockists and over 30 branches across India. And the support from more than 100 authorised service centres that ensure that your switchgear is routinely maintained to operate at its optimum.

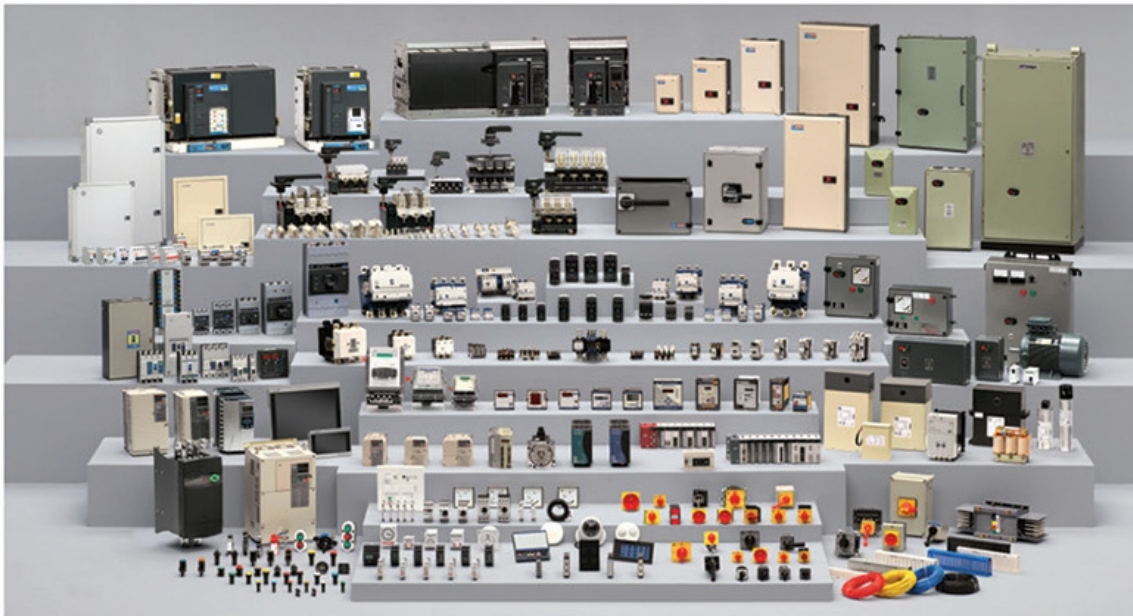

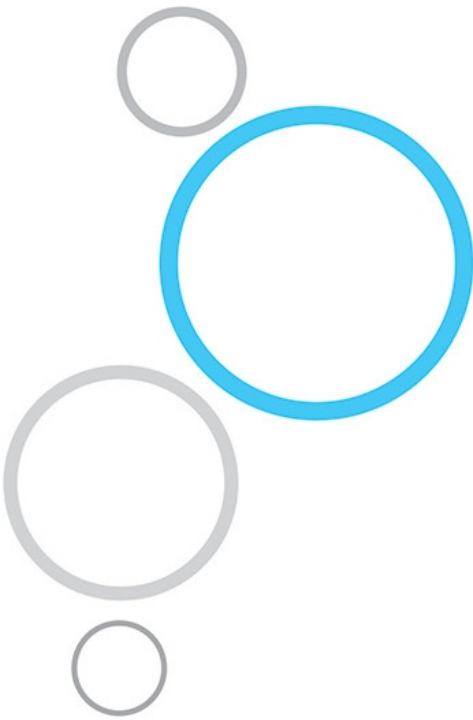

Presenting L&T's New Range of Distribution Boards



Add an appeal to your wall with the state-of-the-art L&T's New Range of DISTRIBUTION BOARDS

The Distribution Boards are a perfect blend of *superior aesthetics, contemporary feel and subtle presence* that gel harmoniously with your décor

L&T's Distribution Board assortment is wide enough to take care of each and every customer requirement with its standard and customized offering

The specially designed 'user interface points' offer-

Total Safety

Installation Convenience

Ease of operation and maintenance

Scan to visit video section



for 3D experience!



Distribution Board Offering

Choice of a DB for a specific application can be made from a **wide range of DB portfolio**

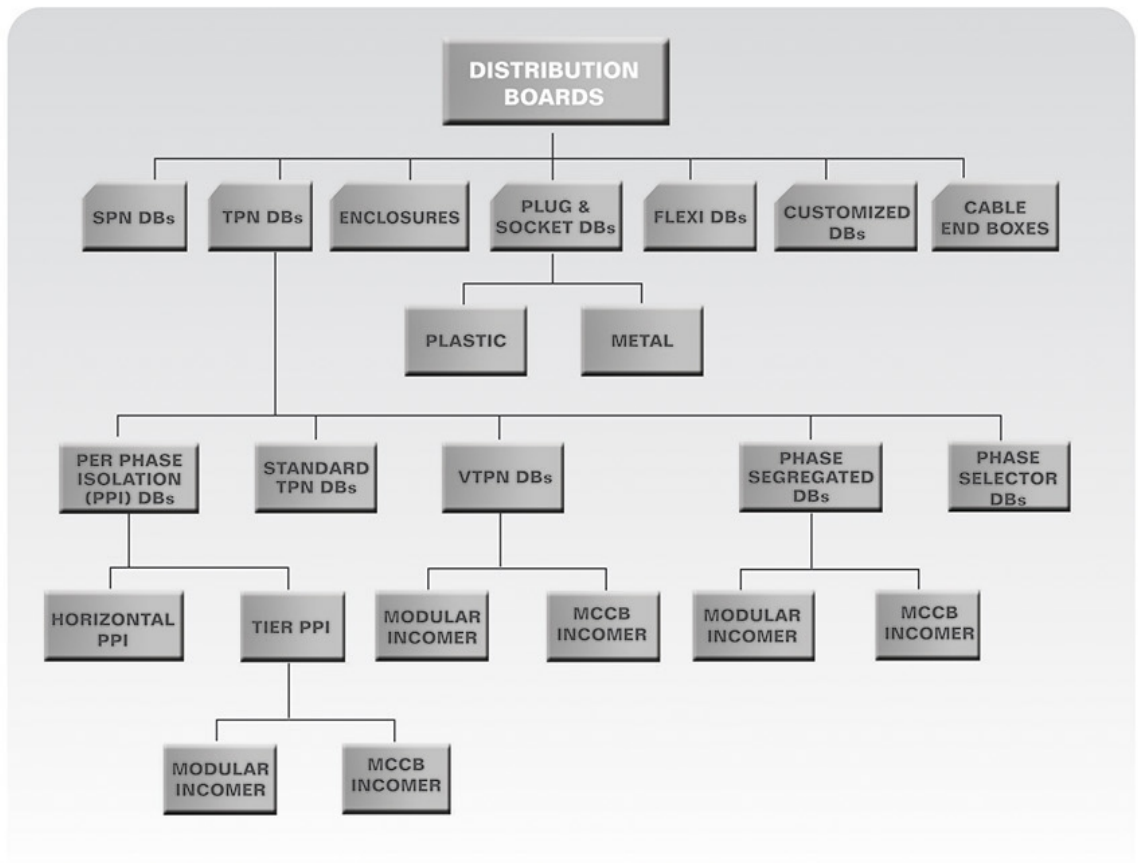

- Available in Single Door - IP 30 ; Double Door - IP 43 and IP 54
- Available in IK 08 , IK 09
- Metal and Glazed door options in Double Door DBs

Certification

Conforms to IS 8623-1 & 3, IEC 61439 -1 & 3



Ingress Protection (IP) Test certificate
Ensures Distribution Boards and Enclosures are well protected against external foreign bodies and liquid



Protection against Mechanical Impact (IK)
Ensures Distribution Boards and Enclosures are well protected from external impact



Complete range of Distribution Boards is RoHS compliant



Customer Benefits

- In order to adapt to site condition, DB door can be reversed at the site

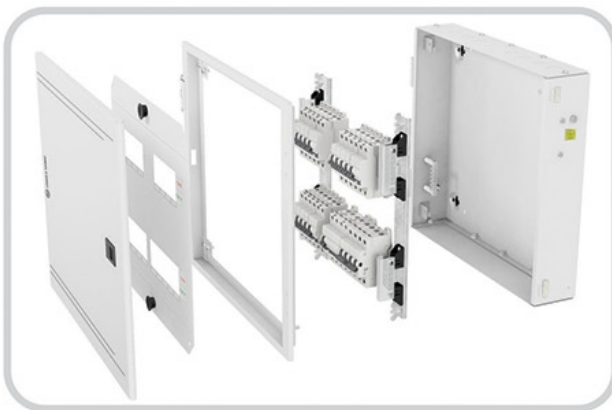

- DB Installation made convenient with **independently removable door, shield, frame & chassis**
- The removal of the chassis, with the neutral bar mounted on it offers immense flexibility during commissioning

- Product mounting and wiring made easy as the products can be conveniently mounted on the chassis and entire assembly can be easily fitted in the DB box with chassis that can be stored separately

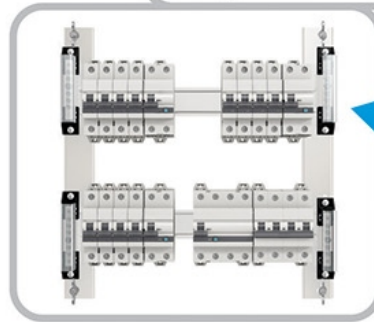

- To avoid unauthorized access to a DB and ensure safety during maintenance, DBs are equipped for installing a **padlock**
- Special latch with a key lock provision also available



- Flush mounting of a DB made easy and perfect fit is achieved with clearly visible **anti insertion marking**



Customer Benefits

- No accidental contact with live parts is ensured with
 - Transparent shrouds for neutral bars →
 - High quality insulation on bus-bars



- Assured level of **Ingress Protection (IP)** with the help of high quality gaskets in double door DBs



- Protection of DB interiors from cement splashes during civil activities with **cement spill protector**



- Ease of wiring is facilitated with removable top and bottom gland plates with adequate number of cut and carry knockouts



- Removing of shield made easy with ergonomically designed holding shield knobs

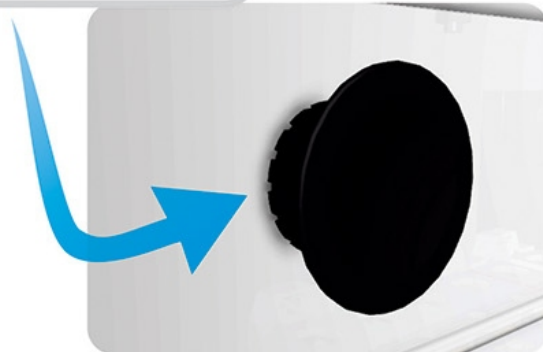

Customer Benefits

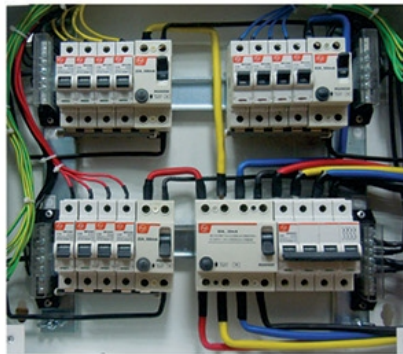

- Safe, neat and clutter-free wiring is facilitated with **adequate space for wiring**

- Complete safety is ensured by **effective earthing** throughout the distribution board with star washers



- Independently packed 'door-frame-shield' ensures-
 - Separate and safe storage at site
 - No damage during civil activities

Superior aesthetics that perfectly blends with your décor





DB Selection Guide

SPN DBs	Page 15
TPN DBs	Page 17
Per Phase Isolation (PPI) DBs	Page 19
Phase Segregated DBs (7 Segment DBs)	Page 21
Phase Selector DBs	Page 23
Flexi /Row DBs	Page 25
Vertical TPN (VTPN) DBs	Page 27
Enclosures	Page 32
Plug & Sockets	Page 33
Cable End Boxes	Page 35
Customized DBs	Page 37
DB Accessories	Page 39
Dimensional Details	Page 43

CAT No. Nomenclature

DISTRIBUTION BOARD

CAT No. String 1 2 3 - 4 - 5 6 7 - 8 9 - 10

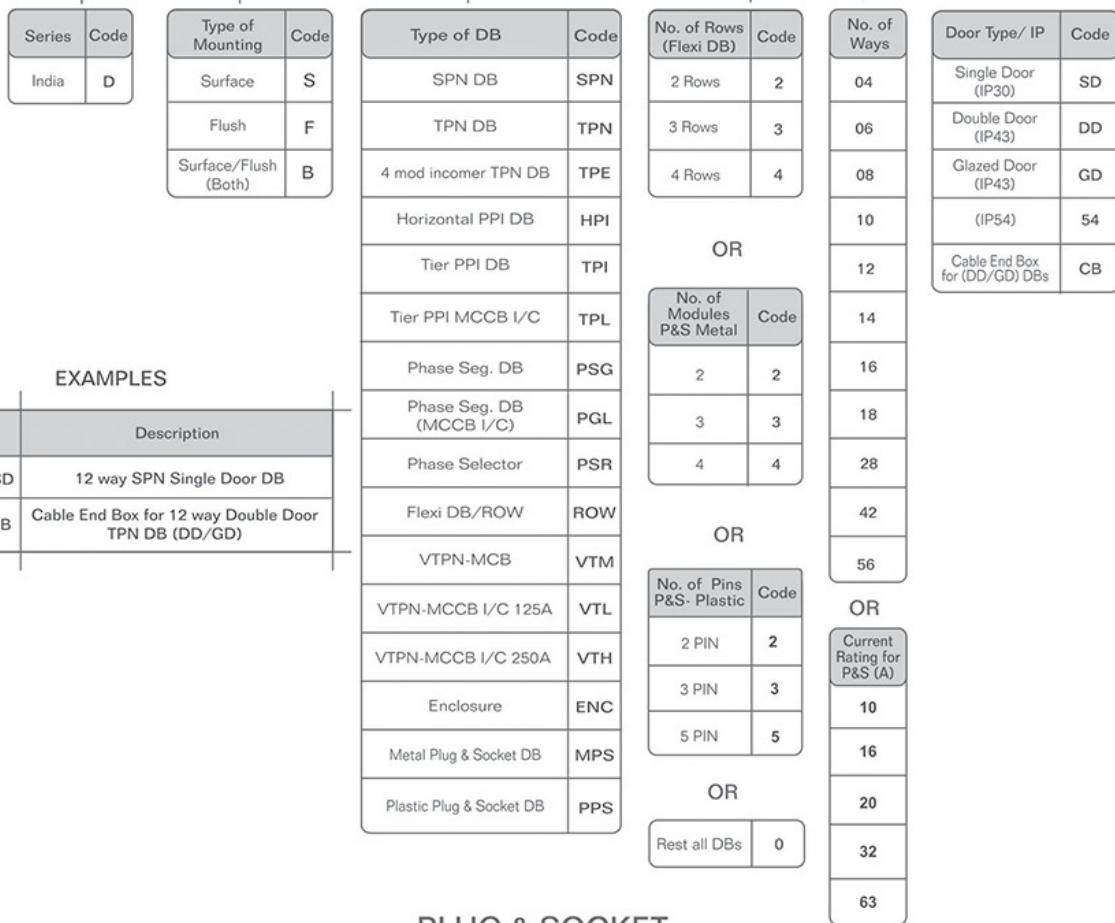

EXAMPLES

CAT Nos.	Description
DB SPN 012 SD	12 way SPN Single Door DB
DB TPN 012 CB	Cable End Box for 12 way Double Door TPN DB (DD/GD)

PLUG & SOCKET

CAT No. String 1 - 2 - 3 4 5 - 6 7

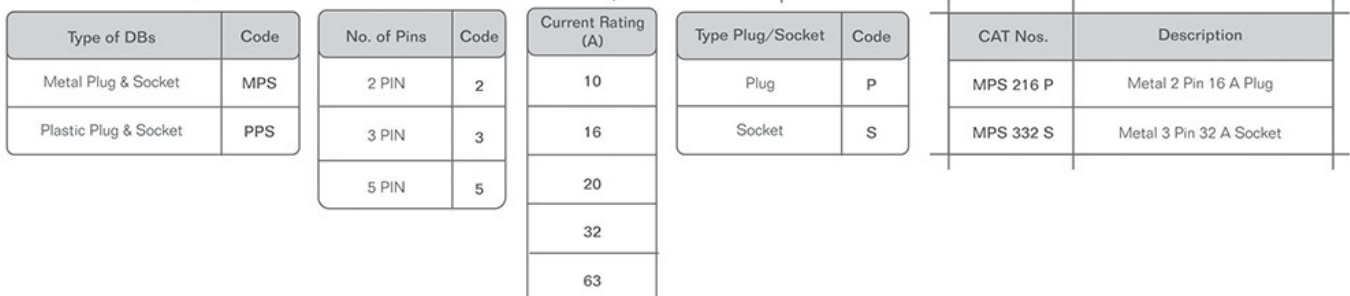

EXAMPLES

CAT Nos.	Description
MPS 216 P	Metal 2 Pin 16 A Plug
MPS 332 S	Metal 3 Pin 32 A Socket

SPN DB



Metal DB for Single Phase and Neutral (SPN) supply distribution

HIGHLIGHTS

- Conforms to IS 8623-1 & 3, IEC 61439-1 & 3
- Available in 4, 6, 8, 12, 16 & 18 ways
- Suitable for Surface and Flush mounting
- IP 30 for single door, IP 43/54 for double door
- IK 08-for single door DBs, IK 09-for double door DBs
- Available in CRCA sheet steel, RAL9003, powder coated
- Ready to use DBs – Provided with 100A insulated phase bus-bar | neutral bar/s with shroud/s | earth bar/s | sticking saddles | cement spill protector | color-coded interconnecting wire set | cable ties | blanking plates and circuit identification label
- Choice of metal or glazed door
- Reversible door for double door DBs
- Independently removable door, shield, chassis and gland plates
- With provision for DP MCB/Isolator/RCCB/RCBO as incomer and SP MCBs as outgoing

Ordering Information

Description	No. of Modules		CAT Nos.
	Incomer + Outgoing		
IP 30 SINGLE DOOR			
4 way	4		DBSPN004SD
6 way	6		DBSPN006SD
8 way	8		DBSPN008SD
12 way	12		DBSPN012SD
16 way	16		DBSPN016SD
18 way	18		DBSPN018SD
IP 43 METAL DOOR			
4 way	4		DBSPN004DD
6 way	6		DBSPN006DD
8 way	8		DBSPN008DD
12 way	12		DBSPN012DD
16 way	16		DBSPN016DD
18 way	18		DBSPN018DD
IP 43 GLAZED DOOR			
4 way	4		DBSPN004GD
6 way	6		DBSPN006GD
8 way	8		DBSPN008GD
12 way	12		DBSPN012GD
16 way	16		DBSPN016GD
18 way	18		DBSPN018GD
IP 54 METAL DOOR			
4 way	4		DBSPN00454
6 way	6		DBSPN00654
8 way	8		DBSPN00854
12 way	12		DBSPN01254
16 way	16		DBSPN01654
18 way	18		DBSPN01854





TPN DB

Metal DB for Three Phase and Neutral (TPN) supply distribution

HIGHLIGHTS

- Conforms to IS 8623-1 & 3, IEC 61439-1 & 3
- Available in 4, 6, 8, 12 & 16 ways
- Suitable for Surface and Flush mounting
- IP 30 for single door, IP 43/54 for double door
- IK 08-for single door DBs, IK 09-for double door DBs
- Available in CRCA sheet steel, RAL 9003, powder coated
- Ready to use DBs – Provided with 100A insulated phase bus-bars | neutral bar/s with shroud/s | earth bar/s | sticking saddles | cement spill protector | color-coded interconnecting wire set | cable ties | blanking plates and circuit identification labels
- Choice of metal or glazed door
- Reversible door for double door DBs
- Independently removable door, shield, chassis and gland plates
- With provision for FP MCB/Isolator/RCCB/RCBO as incomer and SP MCBs as outgoings

Ordering Information

Description	No. of Modules		CAT Nos.
	Incomer	Outgoing	
IP 30 SINGLE DOOR			
4 way	4	4+4+4	DBTPE004SD
6 way	4	6+6+6	DBTPE006SD
4 way	8	4+4+4	DBTPN004SD
6 way	8	6+6+6	DBTPN006SD
8 way	8	8+8+8	DBTPN008SD
12 way	8	12+12+12	DBTPN012SD
16 way	8	16+16+16	DBTPN016SD
IP 43 METAL DOOR			
4 way	4	4+4+4	DBTPE004DD
6 way	4	6+6+6	DBTPE006DD
4 way	8	4+4+4	DBTPN004DD
6 way	8	6+6+6	DBTPN006DD
8 way	8	8+8+8	DBTPN008DD
12 way	8	12+12+12	DBTPN012DD
16 way	8	16+16+16	DBTPN016DD
IP 43 GLAZED DOOR			
4 way	4	4+4+4	DBTPE004GD
6 way	4	6+6+6	DBTPE006GD
4 way	8	4+4+4	DBTPN004GD
6 way	8	6+6+6	DBTPN006GD
8 way	8	8+8+8	DBTPN008GD
12 way	8	12+12+12	DBTPN012GD
16 way	8	16+16+16	DBTPN016GD
IP 54 METAL DOOR			
4 way	4	4+4+4	DBTPE00454
6 way	4	6+6+6	DBTPE00654
4 way	8	4+4+4	DBTPN00454
6 way	8	6+6+6	DBTPN00654
8 way	8	8+8+8	DBTPN00854
12 way	8	12+12+12	DBTPN01254
16 way	8	16+16+16	DBTPN01654





PPI DB



Metal DB for Three Phase and Neutral (TPN) supply distribution with Per Phase Isolation (PPI)

HIGHLIGHTS

- Conforms to IS 8623-1 & 3, IEC 61439-1 & 3
- Available in - Horizontal PPI 4, 6, 8, 12 & 16 ways
- Tier PPI 6, 8, 10, 12 & 16 ways
- Suitable for Surface and Flush mounting
- IP 43/54 for double door
- IK 09 for double door DBs
- Available in CRCA sheet steel, RAL 9003, powder coated
- Ready to use DBs – Provided with 100A insulated phase bus-bars | neutral bar/s with shroud/s | earth bar/s | sticking saddles | cement spill protector | color-coded interconnecting wire set | cable ties | blanking plates and circuit identification labels
- Reversible door for double door DBs
- Independently removable door, frame, shield, chassis and gland plates
- With provision for FP MCB/Isolator/RCCB/RCBO as incomer, DP RCCB /RCBO as sub-incomer and SP MCBs as outgoing

Ordering Information- Horizontal PPI DBs

Description	No. of Modules			CAT Nos.
	Incomer	Sub-Incomer	Outgoing	
IP 43 METAL DOOR				
4 way	8	2+2+2	4+4+4	DBHPI004DD
6 way	8	2+2+2	6+6+6	DBHPI006DD
8 way	8	2+2+2	8+8+8	DBHPI008DD
12 way	8	2+2+2	12+12+12	DBHPI012DD
16 way	8	2+2+2	16+16+16	DBHPI016DD
IP 54 METAL DOOR				
4 way	8	2+2+2	4+4+4	DBHPI00454
6 way	8	2+2+2	6+6+6	DBHPI00654
8 way	8	2+2+2	8+8+8	DBHPI00854
12 way	8	2+2+2	12+12+12	DBHPI01254
16 way	8	2+2+2	16+16+16	DBHPI01654



Ordering Information- Tier PPI DBs

Description	No. of Modules			CAT Nos.
	Incomer	Sub-Incomer	Outgoing	
IP 43 METAL DOOR				
6 way	8	2+2+2	6+6+6	DBTPI006DD
8 way	8	2+2+2	8+8+8	DBTPI008DD
10 way	8	2+2+2	10+10+10	DBTPI010DD
12 way	8	2+2+2	12+12+12	DBTPI012DD
16 way	8	2+2+2	16+16+16	DBTPI016DD
12 way	MCCB*	2+2+2	12+12+12	DBTPL012DD
IP 54 METAL DOOR				
6 way	8	2+2+2	6+6+6	DBTPI00654
8 way	8	2+2+2	8+8+8	DBTPI00854
10 way	8	2+2+2	10+10+10	DBTPI01054
12 way	8	2+2+2	12+12+12	DBTPI01254
16 way	8	2+2+2	16+16+16	DBTPI01654
12 way	MCCB*	2+2+2	12+12+12	DBTPL01254



*Suitable for 3 pole and 4 Pole DU100H MCCB as incomer



TPN Phase Segregated DB

Metal DB for Three Phase and Neutral (TPN) supply distribution with total phase segregation

HIGHLIGHTS

- Conforms to IS 8623-1 & 3, IEC 61439-1 & 3
- Available in 4, 6, 8 & 12 way
- Suitable for Surface and Flush mounting
- IP 30 for single door, IP 43/54 for double door
- IK 08-for single door DBs, IK 09-for double door DBs
- Available in CRCA sheet steel, RAL 9003, powder coated
- Ready to use DBs – Provided with 100A insulated phase bus-bars | neutral bar/s with shroud/s | earth bar/s | sticking saddles | color-coded interconnecting wire set | cable ties | blanking plates and circuit identification labels
- Independently removable door, frame, shield, chassis and gland plates
- With provision for
 1. Modular Incomer - FP MCB/Isolator as incomer, DP RCCB/RCBO as sub-incomer and SP MCBs as outgoing
 2. MCCB Incomer - TP/FP DU100H MCCB as incomer, DP RCCB/RCBO as sub-incomer and SP MCBs as outgoing

Ordering Information - with Modular Incomer

Description	No. of Modules			CAT Nos.
	Incomer	Sub-Incomer	Outgoing	
IP 30 SINGLE DOOR				
4 way	8	4+4+4	4+4+4	DBPSG004SD
6 way	8	4+4+4	6+6+6	DBPSG006SD
8 way	8	4+4+4	8+8+8	DBPSG008SD
12 way	8	4+4+4	12+12+12	DBPSG012SD
IP 43 METAL DOOR				
4 way	8	4+4+4	4+4+4	DBPSG004DD
6 way	8	4+4+4	6+6+6	DBPSG006DD
8 way	8	4+4+4	8+8+8	DBPSG008DD
12 way	8	4+4+4	12+12+12	DBPSG012DD
IP 54 METAL DOOR				
4 way	8	4+4+4	4+4+4	DBPSG00454
6 way	8	4+4+4	6+6+6	DBPSG00654
8 way	8	4+4+4	8+8+8	DBPSG00854
12 way	8	4+4+4	12+12+12	DBPSG01254



Ordering Information - with MCCB Incomer

Description	No. of modules			CAT Nos.
	Incomer*	Sub-Incomer	Outgoing	
IP 30 SINGLE DOOR				
4 way	MCCB	4+4+4	4+4+4	DBPGL004SD
6 way	MCCB	4+4+4	6+6+6	DBPGL006SD
8 way	MCCB	4+4+4	8+8+8	DBPGL008SD
12 way	MCCB	4+4+4	12+12+12	DBPGL012SD
IP 43 METAL DOOR				
4 way	MCCB	4+4+4	4+4+4	DBPGL004DD
6 way	MCCB	4+4+4	6+6+6	DBPGL006DD
8 way	MCCB	4+4+4	8+8+8	DBPGL008DD
12 way	MCCB	4+4+4	12+12+12	DBPGL012DD
IP 54 METAL DOOR				
4 way	MCCB	4+4+4	4+4+4	DBPGL00454
6 way	MCCB	4+4+4	6+6+6	DBPGL00654
8 way	MCCB	4+4+4	8+8+8	DBPGL00854
12 way	MCCB	4+4+4	12+12+12	DBPGL01254



*Suitable for 3 Pole and 4 Pole DU100H MCCB as incomer



TPN Phase selector DB



Metal DB for Three Phase and Neutral (TPN) supply distribution with selector switches for phase selection

HIGHLIGHTS

- Conforms to IS 8623-1 & 3, IEC 61439-1 & 3
- Available in 4, 6, 8, 10 & 12 way
- Suitable for Surface and Flush mounting
- IP 30 for single door, IP 43/54 for double door
- IK 08-for single door DBs, IK 09-for double door DBs
- Available in CRCA sheet steel, RAL 9003, powder coated
- Ready to use DBs – Provided with 3 nos. of 63A Salzer rotary switches | 3 nos. of rocker switches for phase identification | 100A insulated phase bus-bars | neutral bar/s with shroud/s | earth bar/s | sticking saddles | color-coded interconnecting wire set | cable ties | blanking plates and circuit identification labels
- Reversible door for double door DBs
- Independently removable door, frame, shield, chassis and gland plates
- With provision for - FP MCB/Isolator/RCCB/RCBO as incomer SP MCBs as outgoing

Ordering Information

Description	No. of Modules		CAT Nos.
	Incomer	Outgoing	
IP 30 SINGLE DOOR			
4 way	8	4+4+4	DBPSR004SD
6 way	8	6+6+6	DBPSR006SD
8 way	8	8+8+8	DBPSR008SD
10 way	8	10+10+10	DBPSR010SD
12 way	8	12+12+12	DBPSR012SD
IP 43 METAL DOOR			
4 way	8	4+4+4	DBPSR004DD
6 way	8	6+6+6	DBPSR006DD
8 way	8	8+8+8	DBPSR008DD
10 way	8	10+10+10	DBPSR010DD
12 way	8	12+12+12	DBPSR012DD
IP 54 METAL DOOR			
4 way	8	4+4+4	DBPSR00454
6 way	8	6+6+6	DBPSR00654
8 way	8	8+8+8	DBPSR00854
10 way	8	10+10+10	DBPSR01054
12 way	8	12+12+12	DBPSR01254





Flexi/Row DB



Metal DB with flexibility to mount incoming and outgoing as per requirement

HIGHLIGHTS

- Conforms to IS 8623-1 & 3, IEC 61439-1 & 3
- Available in 2, 3 rows in 14 modules per row and 4 Rows in 14/16 modules per row
- Suitable for Surface and Flush mounting
- IP 30 for single door, IP 43/54 for double door
- IK 08-for single door DBs, IK 09-for double door DBs
- Available in CRCA sheet steel, RAL 9003, powder coated
- Ready to use DBs – neutral bar/s with shroud/s | earth bar/s | sticking saddles | cement spill protector | cable ties | blanking plates and circuit identification labels
- Choice of metal or glazed door
- Reversible door for double door DBs
- Independently removable door, frame, shield, chassis and gland plates
- With provision to mount modular devices as per requirement

Ordering Information

Description	No. of Modules Per Row	CAT Nos.
IP 30 SINGLE DOOR		
2 Row 28 Module	14	DBROW228SD
3 Row 42 Module	14	DBROW342SD
4 Row 56 Module	14	DBROW456SD
4 Row 64 Module	16	DBROW464SD
IP 43 METAL DOOR		
2 Row 28 Module	14	DBROW228DD
3 Row 42 Module	14	DBROW342DD
4 Row 56 Module	14	DBROW456DD
4 Row 64 Module	16	DBROW464DD
IP 43 GLAZED DOOR		
2 Row 28 Module	14	DBROW228GD
3 Row 42 Module	14	DBROW342GD
4 Row 56 Module	14	DBROW456GD
4 Row 64 Module	16	DBROW464GD
IP 54 METAL DOOR		
2 Row 28 Module	14	DBROW22854
3 Row 42 Module	14	DBROW34254
4 Row 56 Module	14	DBROW45654
4 Row 64 Module	16	DBROW46454





Vertical TPN DB with Modular Incomer

Metal DB with vertical bus-bar for Three-Phase and Neutral (TPN) supply distribution

HIGHLIGHTS

- Conforms to IS 8623-1 & 3, IEC 61439-1 & 3
- Available in 4, 6, 8, 12 & 16 ways
- Suitable for Surface and Flush mounting
- IP 30 for single door, IP 43/54 for double door
- IK 08-for single door DBs, IK 09-for double door DBs
- Bus-bar: Rated 125A with short-time withstand rating of 10kA for 1 sec
- Available in CRCA sheet steel, RAL 9003, powder coated
- Ready to use DBs – Provided with insulated vertical phase bus-bars | neutral bar/s with shroud/s | earth bar/s | sticking saddles | cement spill protector | color-coded interconnecting wire set | cable ties | blanking plates and circuit identification labels
- Choice of metal or glazed door
- Reversible door for double door DBs
- Independently removable door, frame, shield, chassis and gland plates
- With provision for FP MCB/Isolator/RCCB/RCBO as incomer and SP/TP MCBs as outgoing

Ordering Information

Description	No. of Modules		CAT Nos.
	Incomer	Outgoing	
IP 30 SINGLE DOOR			
4 way	8	4+4+4	DBVTM004SD
6 way	8	6+6+6	DBVTM006SD
8 way	8	8+8+8	DBVTM008SD
12 way	8	12+12+12	DBVTM012SD
16 way	8	16+16+16	DBVTM016SD
IP 43 METAL DOOR			
4 way	8	4+4+4	DBVTM004DD
6 way	8	6+6+6	DBVTM006DD
8 way	8	8+8+8	DBVTM008DD
12 way	8	12+12+12	DBVTM012DD
16 way	8	16+16+16	DBVTM016DD
IP 43 GLAZED DOOR			
4 way	8	4+4+4	DBVTM004GD
6 way	8	6+6+6	DBVTM006GD
8 way	8	8+8+8	DBVTM008GD
12 way	8	12+12+12	DBVTM012GD
16 way	8	16+16+16	DBVTM016GD
IP 54 METAL DOOR			
4 way	8	4+4+4	DBVTM00454
6 way	8	6+6+6	DBVTM00654
8 way	8	8+8+8	DBVTM00854
12 way	8	12+12+12	DBVTM01254
16 way	8	16+16+16	DBVTM01654



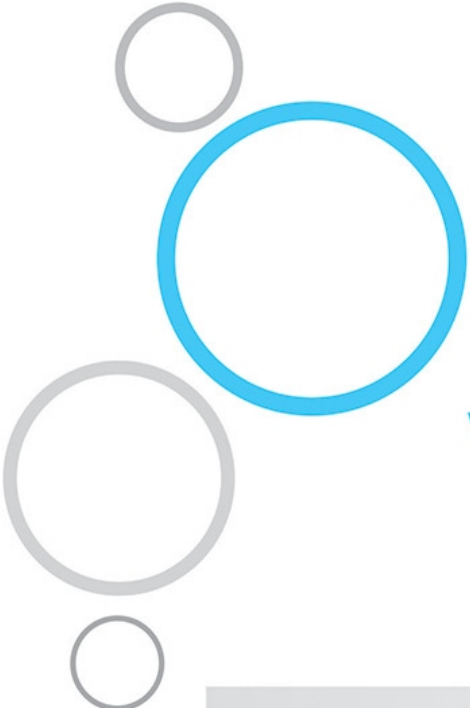

Vertical TPN DB with MCCB Incomer

HIGHLIGHTS

- Conforms to IS 8623-1 & 3, IEC 61439-1 & 3
- Available in 4, 6, 8, 12 & 16 way
- Suitable for Surface and Flush mounting
- IP 30 for single door, IP 43/54 for double door
- IK 08-for single door DBs, IK 09-for double door DBs
- Bus-bar rating -125A , 250A with a short-time withstand rating of 10kA for 1 sec
- Available in CRCA sheet steel, RAL 9003, powder coated
- Ready to use DBs – Provided with insulated vertical phase bus-bars | neutral bar/s with shroud/s | earth bar/s | sticking saddles | cement spill protector | color-coded interconnecting wire set | cable ties | blanking plates and circuit identification labels
- Choice of metal or glazed door
- Reversible door for double door DBs
- Independently removable door, frame, shield, chassis and gland plates
- With provision for MCCB* as incomer and SP/TP MCBs as outgoings

*Suitable for 3 pole and 4 Pole MCCB as incomer

A) Up to 125 A - DU100H, DU125H (Icu = 30kA, Ics = 50% Icu)

B) Up to 250 A - DU250 (Icu = 36kA , Ics = 50% Icu)

Ordering Information - Up to 125A MCCB Incomer

Description	No. of Modules		CAT Nos.
	Incomer*	Outgoing	
IP 30 SINGLE DOOR			
4 way	MCCB	4+4+4	DBVTL004SD
6 way	MCCB	6+6+6	DBVTL006SD
8 way	MCCB	8+8+8	DBVTL008SD
12 way	MCCB	12+12+12	DBVTL012SD
16 way	MCCB	16+16+16	DBVTL016SD
IP 43 METAL DOOR			
4 way	MCCB	4+4+4	DBVTL004DD
6 way	MCCB	6+6+6	DBVTL006DD
8 way	MCCB	8+8+8	DBVTL008DD
12 way	MCCB	12+12+12	DBVTL012DD
16 way	MCCB	16+16+16	DBVTL016DD
IP 43 GLAZED DOOR			
4 way	MCCB	4+4+4	DBVTL004GD
6 way	MCCB	6+6+6	DBVTL006GD
8 way	MCCB	8+8+8	DBVTL008GD
12 way	MCCB	12+12+12	DBVTL012GD
16 way	MCCB	16+16+16	DBVTL016GD
IP 54 METAL DOOR			
4 way	MCCB	4+4+4	DBVTL00454
6 way	MCCB	6+6+6	DBVTL00654
8 way	MCCB	8+8+8	DBVTL00854
12 way	MCCB	12+12+12	DBVTL01254
16 way	MCCB	16+16+16	DBVTL01654



*Suitable for 3 pole and 4 Pole DU100H, DU125H MCCB as incomer



Ordering Information - Up to 250A MCCB Incomer

Description	No. of Modules		CAT Nos.
	Incomer*	Outgoing	
IP 30 SINGLE DOOR			
4 way	MCCB	4+4+4	DBVTH004SD
6 way	MCCB	6+6+6	DBVTH006SD
8 way	MCCB	8+8+8	DBVTH008SD
12 way	MCCB	12+12+12	DBVTH012SD
16 way	MCCB	16+16+16	DBVTH016SD
IP 43 METAL DOOR			
4 way	MCCB	4+4+4	DBVTH004DD
6 way	MCCB	6+6+6	DBVTH006DD
8 way	MCCB	8+8+8	DBVTH008DD
12 way	MCCB	12+12+12	DBVTH012DD
16 way	MCCB	16+16+16	DBVTH016DD
IP 43 GLAZED DOOR			
4 way	MCCB	4+4+4	DBVTH004GD
6 way	MCCB	6+6+6	DBVTH006GD
8 way	MCCB	8+8+8	DBVTH008GD
12 way	MCCB	12+12+12	DBVTH012GD
16 way	MCCB	16+16+16	DBVTH016GD
IP 54 METAL DOOR			
4 way	MCCB	4+4+4	DBVTH00454
6 way	MCCB	6+6+6	DBVTH00654
8 way	MCCB	8+8+8	DBVTH00854
12 way	MCCB	12+12+12	DBVTH01254
16 way	MCCB	16+16+16	DBVTH01654

*Suitable for 3 pole and 4 Pole DU250 MCCB as incomer

Enclosure



Metal enclosure for flush and surface mounting

HIGHLIGHTS

- Conforms to IS 8623-1 & 3, IEC 61439-1 & 3
- Available in 2, 3, 4 & 6 way
- Suitable for Surface and Flush mounting
- In single door version, IP 30, IK 08
- Available in CRCA sheet steel, RAL 9003, powder coated
- Ready to use Enclosures
- Independently removable shield
- With provision to mount MCB/Isolator/RCCB/RCBO and other modular devices

Ordering Information

Description	No. of Modules	CAT Nos.
IP 30 SINGLE DOOR		
2 way	2	DBENC002SD
3 way	3	DBENC003SD
4 way	4	DBENC004SD
6 way	6	DBENC006SD



Plug & Socket DB



Metal-clad/Plastic Plug & Socket outlets for supplying power to specific loads

HIGHLIGHTS

- Conforms to IS 8623-1 & 3, IEC 61439-1 & 3
- Available in Single Phase - 10A, 16A, 20A, 32A; Three Phase - 20A, 32A & 63A
- Suitable for Surface and Flush mounting
- Available in CRCA sheet steel, RAL 9003, powder coated
- IP 30 for metal clad units
- IP 44 for insulated P&S units (IP 30 for enclosures)
- Ready to use DBs –provided with neutral bar/s with shroud/s in 1 and 3 module DBs | color-coded interconnecting wires sets
- Independently removable shield
- Loose Metal Plugs & Sockets conform to IS 8804;available in Single Phase & Three Phase

Ordering Information

Description	No. of Pins	No. of Modules	CAT Nos.
METAL PLUG & SOCKETS			
10A, 2 Pin + SC	P+N	1	DBMPS110SD
20A, 2 Pin + SC	P+N	1	DBMPS120SD
20A, 2 Pin + SC	P+N	2	DBMPS220SD
20A, 3 Pin + SC	3P	3	DBMPS320SD
32A, 3 Pin + SC	3P	3	DBMPS332SD
32A, 3 Pin + SC	3P	4	DBMPS432SD
63A, 5 Pin + SC	3P+N+E	4	DBMPS463SD
PLASTIC PLUG & SOCKETS			
16A, 3 Pin	P+N+E	2	DBPPS316SD
32A, 3 Pin	P+N+E	4	DBPPS332SD
32A, 5 Pin	3P+N+E	8	DBPPS532SD
63A, 5 Pin	3P+N+E	8	DBPPS563SD



Ordering Information: Metal plug

Description	No. of Pins	CAT Nos.
10A, 2 Pin + SC	P+N	MPS210P
20A, 2 Pin + SC	P+N	MPS220P
20A, 3 Pin + SC	3P	MPS320P
32A, 3 Pin + SC	3P	MPS332P



Ordering Information: Metal socket

Description	No. of Pins	CAT Nos.
10A, 2 Pin + SC	P+N	MPS210S
20A, 2 Pin + SC	P+N	MPS220S
20A, 3 Pin + SC	3P	MPS320S
32A, 3 Pin + SC	3P	MPS332S



SC-Scraping Earth



Cable End Boxes



To accommodate extra length of wires

HIGHLIGHTS

- Available in CRCA sheet steel, RAL 9003, powder coated
- Can be either at the top or bottom of the distribution board

Ordering Information

Description	CAT Nos.
CEB for SPN DBs	
CEB-SPN Double Door, 4 way	DBSPN004CB
CEB-SPN Double Door, 6 way	DBSPN006CB
CEB-SPN Double Door, 8 way	DBSPN008CB
CEB-SPN Double Door, 12 way	DBSPN012CB
CEB-SPN Double Door, 16 way	DBSPN016CB
CEB-SPN Double Door, 18 way	DBSPN018CB
CEB for TPN DBs	
CEB-TPN Double Door, 4 way	DBTPN004CB
CEB-TPN Double Door, 6 way	DBTPN006CB
CEB-TPN Double Door, 8 way	DBTPN008CB
CEB-TPN Double Door, 12 way	DBTPN012CB
CEB-TPN Double Door, 16 way	DBTPN016CB
CEB-TPE Double Door, 4 way	DBTPE004CB
CEB-TPE Double Door, 6 way	DBTPE006CB
CEB for HORIZONTAL PPI DBs	
CEB-Horz. PPI Double Door, 4 way	DBHPI004CB
CEB-Horz. PPI Double Door, 6 way	DBHPI006CB
CEB-Horz. PPI Double Door, 8 way	DBHPI008CB
CEB-Horz. PPI Double Door, 12 way	DBHPI012CB
CEB-Horz. PPI Double Door, 16 way	DBHPI016CB
CEB for TIER PPI DBs	
CEB-Tier PPI Double Door, 6 way	DBTPI006CB
CEB-Tier PPI Double Door, 8 way	DBTPI008CB
CEB-Tier PPI Double Door, 10 way	DBTPI010CB
CEB-Tier PPI Double Door, 12 way	DBTPI012CB
CEB-Tier PPI Double Door, 16 way	DBTPI016CB
CEB-Tier PPI Double Door, 12 way MCCB incomer	DBTPL012CB

Ordering Information

Description	CAT Nos.
CEB for VTPN DBs	
CEB-VTPN Double Door, Modular Incomer	DBVTMXXxCB
CEB-VTPN Double Door, MCCB Incomer	DBVTXXXxCB
CEB for FLEXI DBs	
CEB for Flexi DBS with 14 Modules per Row	DBROWX14CB
CEB for Flexi DBS with 16 Modules per Row	DBROWX16CB
CEB for PHASE SEGREGATED DBs	
CEB-PSG Double Door, 4 way	DBPSG004CB
CEB-PSG Double Door, 6 way	DBPSG006CB
CEB-PSG Double Door, 8 way	DBPSG008CB
CEB-PSG Double Door, 12 way	DBPSG012CB
CEB for PHASE SELECTOR DBs	
CEB-Phase Selector Double Door, 4 way	DBPSR004CB
CEB-Phase Selector Double Door, 6 way	DBPSR006CB
CEB-Phase Selector Double Door, 8 way	DBPSR008CB
CEB-Phase Selector Double Door, 10 way	DBPSR010CB
CEB-Phase Selector Double Door, 12 way	DBPSR012CB

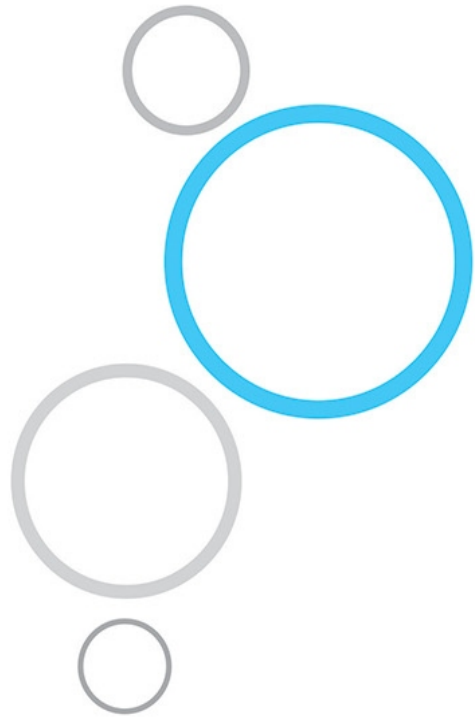

Customized Distribution Boards

Apart from the wide range of standard distribution boards, we also offer various customized solutions as per specific customer requirement

Customized Distribution Boards include pre wired DBs, DBs with provision for TV/Telephone splitters, 8 segment DBs, DBs with auto-manual switches, etc.

Prewired DBs

- Distribution Boards with factory fitted phase and neutral terminal blocks for termination of incoming and outgoing wires
- Available in both Single Phase and Three Phase DB versions

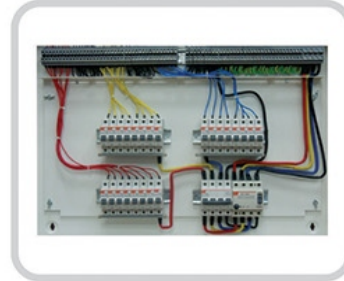

DBs with provision for TV/Telephone Splitters

- Distribution Boards equipped with provisions to mount TV-Telephone splitters
- Available in both Single phase and Three phase DB versions



8 segment DBs

Distribution Boards with phase segregation between incomer, sub incomer, outgoings and supply changeover sections



DBs with Auto manual switches

- Distribution Boards with inbuilt auto-manual switches
- Available in both Single phase and Three phase DB versions



For any other customized requirements please contact nearest L&T branch

DB Accessories

A wide range of accessories to complement the Distribution Board's portfolio

Bus bar – Fork type

To connect number of outgoing MCBs in a distribution board

HIGHLIGHTS

- Conforms to IEC 61439-3
- Available in Single Pole, Double Pole, Three Pole and Four Pole versions
- Material : Copper

Ordering Information

Description	CAT Nos.
SP 13 Mod	BSP13
SP 56 Mod	BSP56
DP 12 Mod	BDP12
TP 12 Mod	BTP12
FP 12 Mod	BFP12

Description	CAT Nos.
End Caps for SP	ECP01
End Caps for DP	ECP02
End Caps for TP	ECP03
End Caps for FP	ECP04



Blanking Plates

To cover the spare space in a distribution board

HIGHLIGHTS

- Available in One module and Half module

Ordering Information

Description	CAT Nos.
One Module	BKP10
Half Module	BKP05



Padlock

To avoid unauthorized access to a DB, and to ensure safety during maintenance

HIGHLIGHTS

- Available in two versions
 1. Version to mount your own lock
 2. Version with standard lock and a common key

Ordering Information

Description	CAT Nos.
Standard Padlock kit with provision to mount your own lock	PDL01
Lock and key kit	PDK02



















Ingress Protection (IP)

The protection of distribution boards and enclosures against ingress of dirt or against the ingress of water is defined in IEC60529.

The degrees of protection are most commonly expressed as 'IP' followed by two numbers, e.g. IP 43, where the numbers define the degree of protection.

IP X X

1 st Digit		2 nd Digit	
Protection against Human Contact / Protection against Foreign Bodies		Protection against Water Ingress	
0	No protection 	0	No protection 
1	With back of hand / Large foreign bodies, dia. >50mm 	1	Water dripping vertically 
2	With a finger / Medium-sized foreign bodies, dia. >12.5mm 	2	Water dripping at an angle (up to 15 degrees from the vertical) 
3	With tools and wires etc with a thickness >2.5mm / Small foreign bodies, dia. >2.5mm 	3	Spray water (any direction up to 60 degrees from the vertical) 
4	With tools and wires etc with a thickness >1mm / Granular foreign bodies, dia. >1mm 	4	Spray water from all directions 
5	Complete protection / Dust protected 	5	Water jets from a nozzle in all directions 
6	Complete protection / Dust proof 	6	High pressure jets 
		7	Temporary immersion 
		8	Permanent immersion 

Protection against Mechanical Impact (IK)

It is the degree of protection provided by distribution boards and enclosures for electrical equipment against external mechanical impacts as provided in the international standard IEC 62262. It provides a means of specifying the capacity of an enclosure to protect inside devices from external impacts.

IK	IMPACT ENERGY (J)	EQUIVALENT IMPACT
00	Unprotected	No Test
01	0.14	Drop of 250 g object from 5.6 cm height
02	0.2	Drop of 200 g object from 10 cm height
03	0.35	Drop of 250 g object from 14 cm height
04	0.5	Drop of 200 g object from 25 cm height
05	0.7	Drop of 250 g object from 28 cm height
06	1	Drop of 250 g object from 40 cm height
07	2	Drop of 500 g object from 40 cm height
08	5	Drop of 1.7 kg object from 30 cm height
09	10	Drop of 5 kg object from 20 cm height
10	20	Drop of 5 kg object from 40 cm height

Dimension Details SPN DB

IP 30 single door

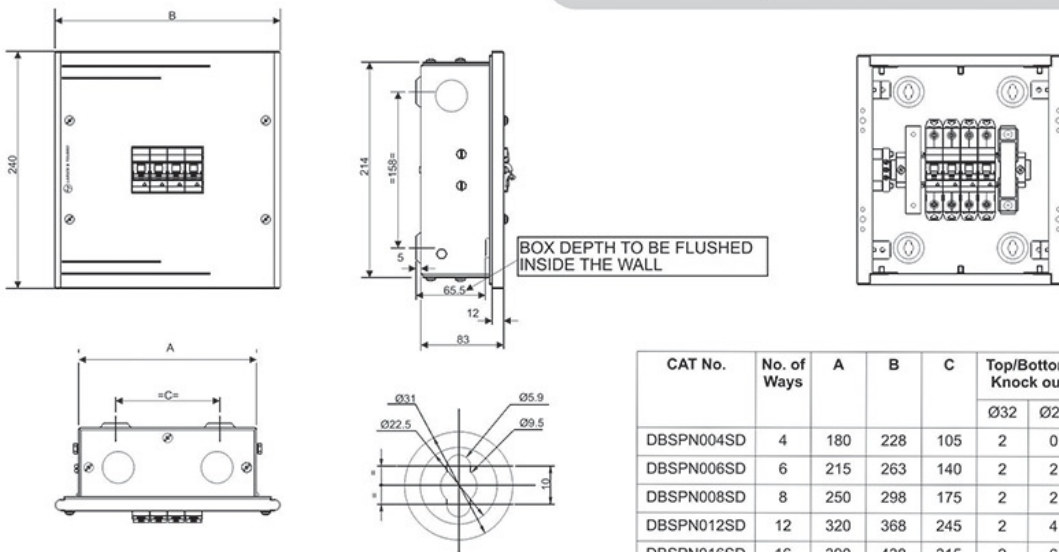

MOUNTING HOLE DETAILS
SUITABLE FOR M8 BOLT

CAT No.	No. of Ways	A	B	C	Top/Bottom Knock out		Side Knock out
					Ø32	Ø25	Ø32
DBSPN004SD	4	180	228	105	2	0	1
DBSPN006SD	6	215	263	140	2	2	1
DBSPN008SD	8	250	298	175	2	2	1
DBSPN012SD	12	320	368	245	2	4	1
DBSPN016SD	16	390	438	315	2	6	1
DBSPN018SD	18	425	473	350	2	6	1

IP 43 metal door

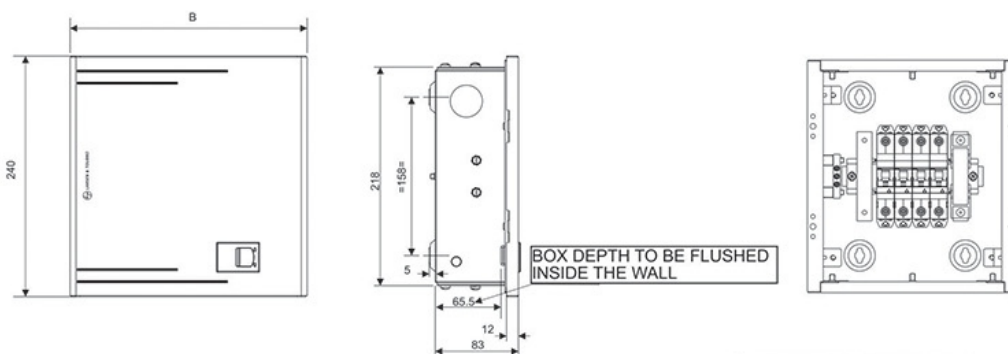

MOUNTING HOLE DETAILS
SUITABLE FOR M8 BOLT

CAT No.	No. of Ways	A	B	C	Top/Bottom Knock out		Side Knock out
					Ø32	Ø25	Ø32
DBSPN004DD	4	180	236	105	2	0	1
DBSPN006DD	6	215	271	140	2	2	1
DBSPN008DD	8	250	306	175	2	2	1
DBSPN012DD	12	320	376	245	2	4	1
DBSPN016DD	16	390	446	315	2	6	1
DBSPN018DD	18	425	481	350	2	6	1

IP 43 glazed door

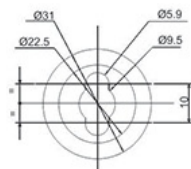
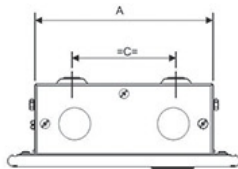
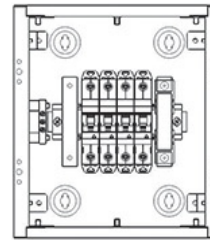
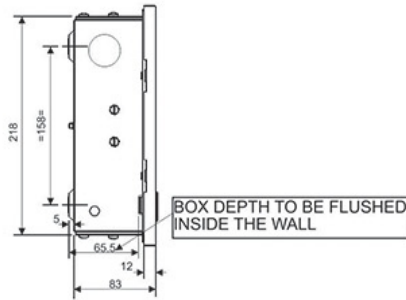
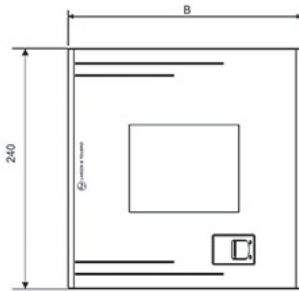

MOUNTING HOLE DETAILS
SUITABLE FOR M8 BOLT

CAT No.	No. of Ways	A	B	C	Top/Bottom Knock out		Side Knock out
					Ø32	Ø25	Ø32
DBSPN004GD	4	180	236	105	2	0	1
DBSPN006GD	6	215	271	140	2	2	1
DBSPN008GD	8	250	306	175	2	2	1
DBSPN012GD	12	320	376	245	2	4	1
DBSPN016GD	16	390	446	315	2	6	1
DBSPN018GD	18	425	481	350	2	6	1

IP 54 metal door

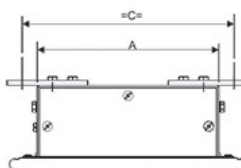
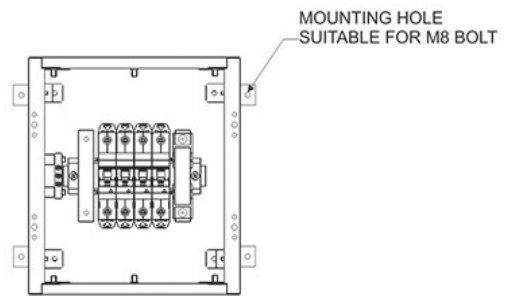
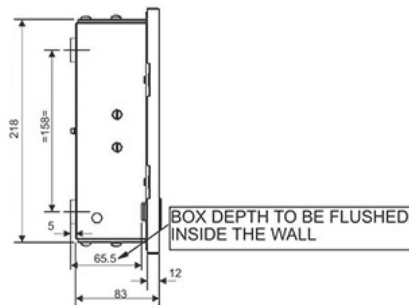
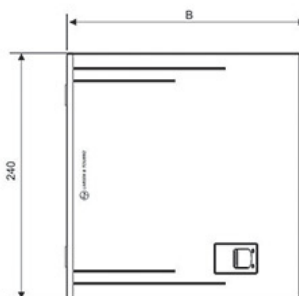

CAT No.	No. of Ways	A	B	C
DBSPN00454	4	180	236	210
DBSPN00654	6	215	271	245
DBSPN00854	8	250	306	280
DBSPN01254	12	320	376	350
DBSPN01654	16	390	446	420
DBSPN01854	18	425	481	455

UNLESS OTHERWISE SPECIFIED DIMENSIONS ARE IN mm
TOLERANCE ON DIMENSIONS = ±2 mm

Dimension Details TPN DB

IP 30 single door

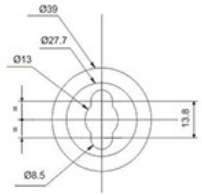
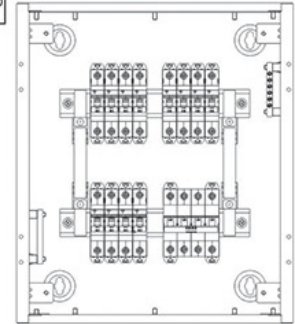
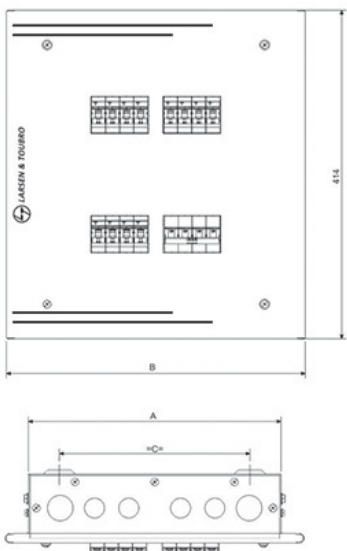

MOUNTING HOLE DETAILS
SUITABLE FOR M12 BOLT

CAT No.	No. of Ways	A	B	C	Top/Bottom Knock out		Side Knock out	
					Ø32	Ø25	Ø32	Ø25
DBTPE004SD	4	317	375	252	2	4	1	2
DBTPE006SD	6	357	415	292	2	4	1	2
DBTPN004SD	4	357	415	292	2	4	1	2
DBTPN006SD	6	398	455	332	2	6	1	2
DBTPN008SD	8	462	520	387	2	8	1	2
DBTPN012SD	12	655	705	584	2	12	1	2
DBTPN016SD	16	793	850	725	2	14	1	2

IP 43 metal door

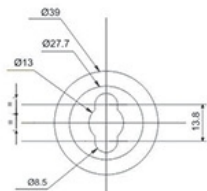
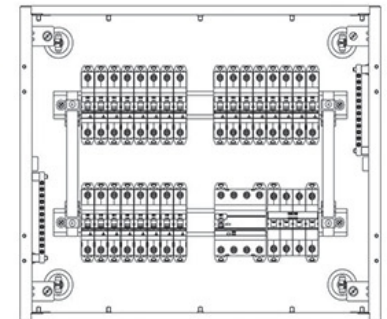
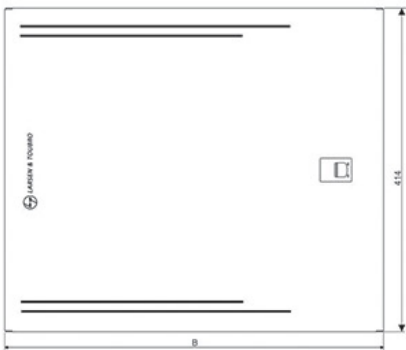

MOUNTING HOLE DETAILS
SUITABLE FOR M12 BOLT

CAT No.	No. of Ways	A	B	C	Top/Bottom Knock out		Side Knock out	
					Ø32	Ø25	Ø32	Ø25
DBTPE004DD	4	317	375	252	2	4	1	2
DBTPE006DD	6	357	412	292	2	4	1	2
DBTPN004DD	4	357	412	292	2	4	1	2
DBTPN006DD	6	398	451	332	2	6	1	2
DBTPN008DD	8	462	517	387	2	8	1	2

IP 43 metal door

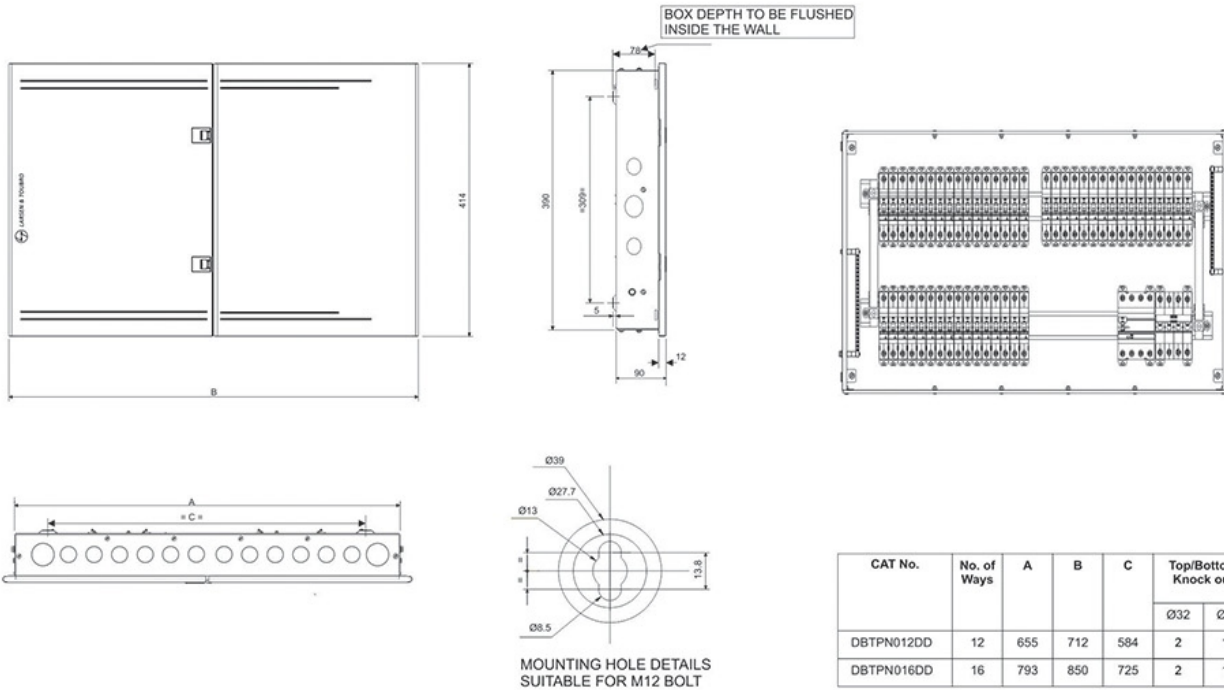

IP 43 glazed door

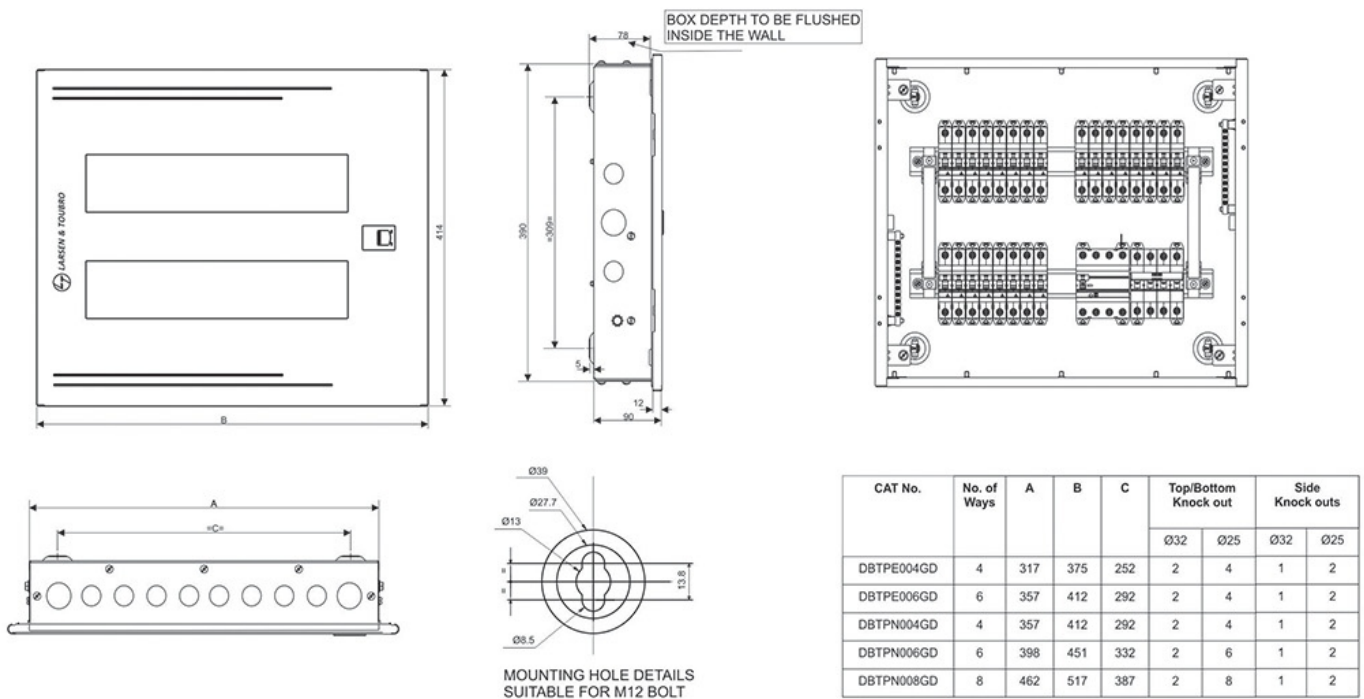

UNLESS OTHERWISE SPECIFIED DIMENSIONS ARE IN mm
TOLERANCE ON DIMENSIONS = ±2 mm

Dimension Details TPN DB

IP 43 glazed door

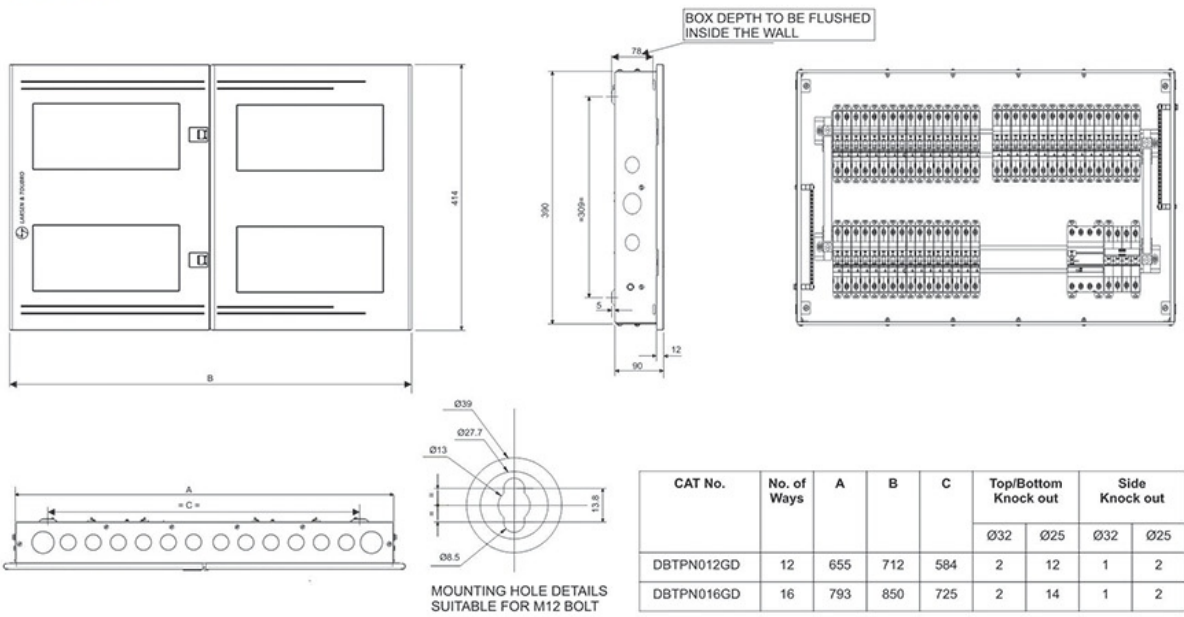

IP 54 metal door

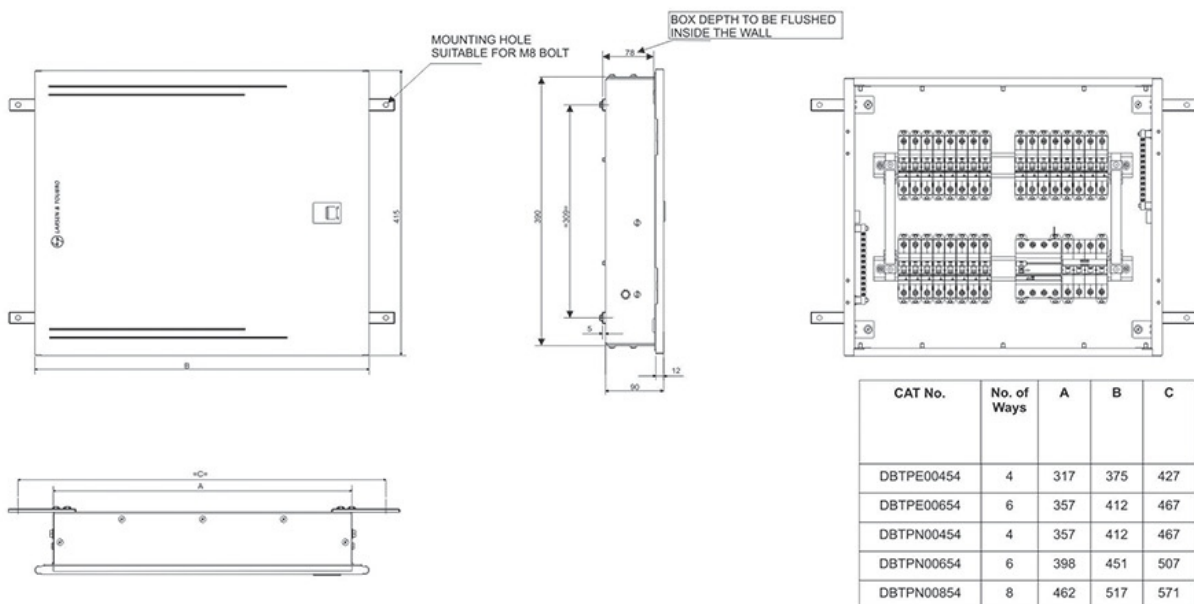

IP 54 metal door

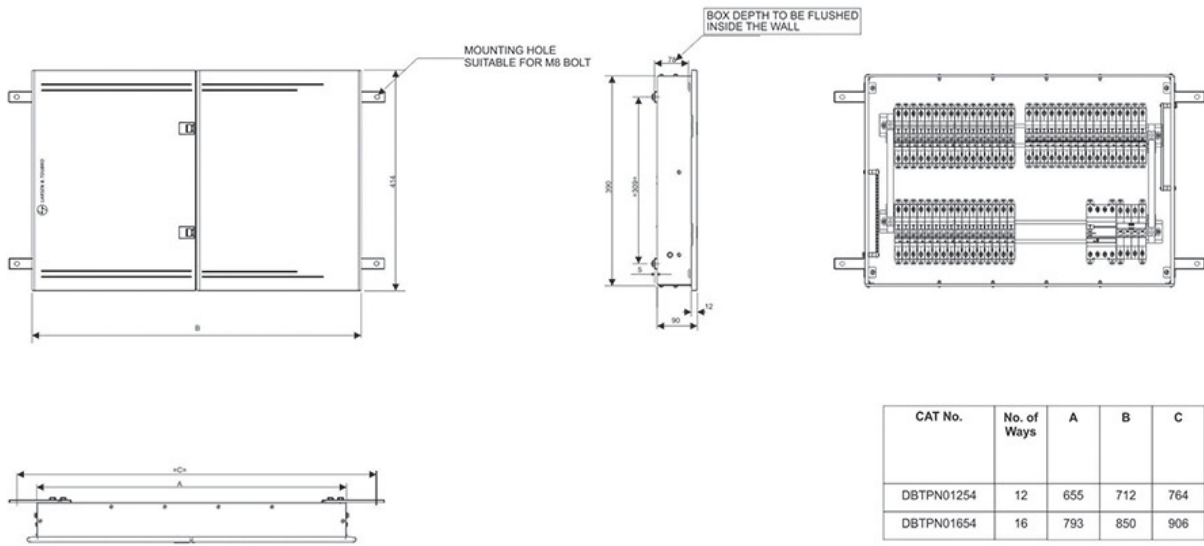

UNLESS OTHERWISE SPECIFIED DIMENSIONS ARE IN mm
TOLERANCE ON DIMENSIONS = ± 2 mm

Dimension Details Horizontal PPI DB

IP 43 metal door

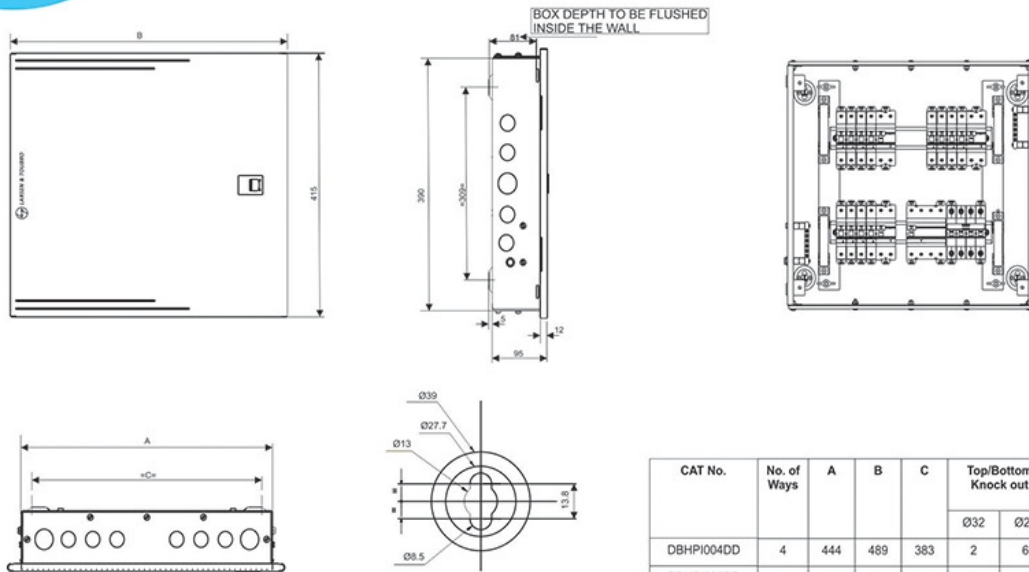

CAT No.	No. of Ways	A	B	C	Top/Bottom Knock out		Side Knock out	
					Ø32	Ø25	Ø32	Ø25
DBHPI004DD	4	444	489	383	2	6	1	4
DBHPI006DD	6	479	525	418	2	8	1	4
DBHPI008DD	8	549	595	487	2	9	1	4

MOUNTING HOLE DETAILS SUITABLE FOR M12 BOLT

IP 43 metal door

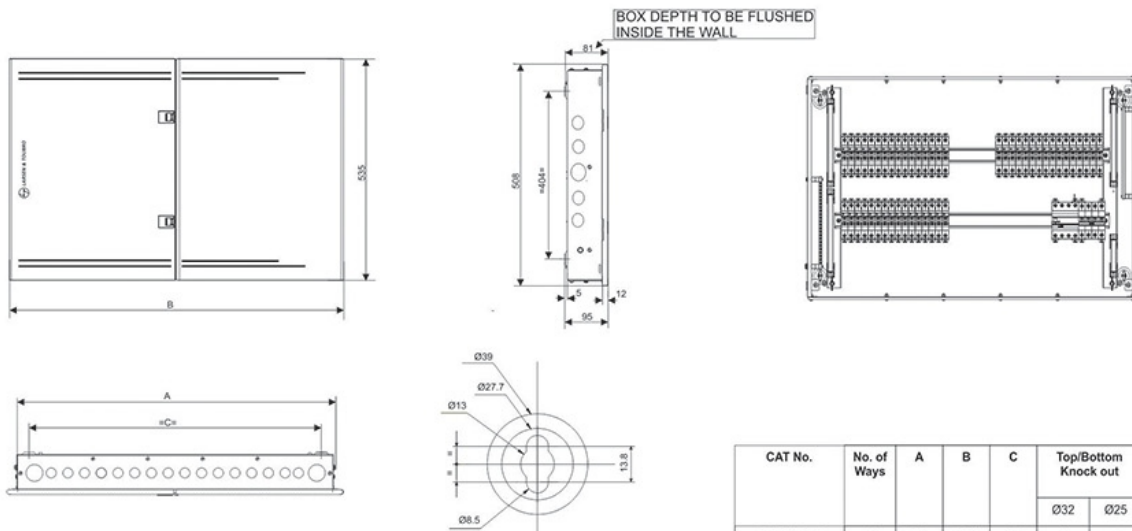

CAT No.	No. of Ways	A	B	C	Top/Bottom Knock out		Side Knock out	
					Ø32	Ø25	Ø32	Ø25
DBHPI012DD	12	723	776	655	2	14	1	4
DBHPI016DD	16	868	921	800	2	18	1	4

MOUNTING HOLE DETAILS SUITABLE FOR M12 BOLT

IP 54 metal door

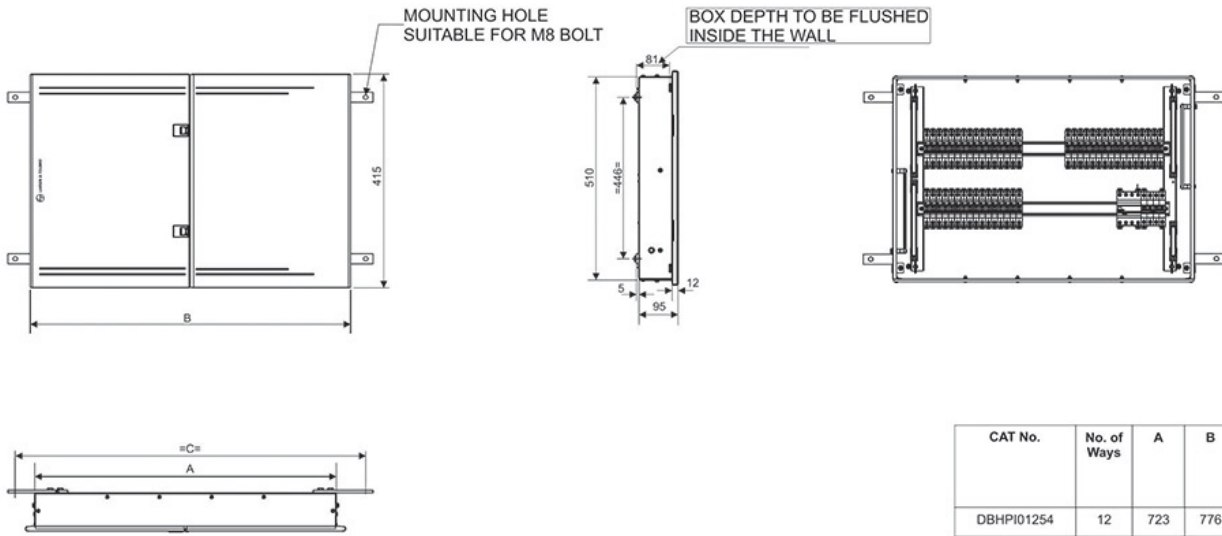

CAT No.	No. of Ways	A	B	C
DBHPI01254	12	723	776	832
DBHPI01654	16	868	921	977

IP 54 metal door

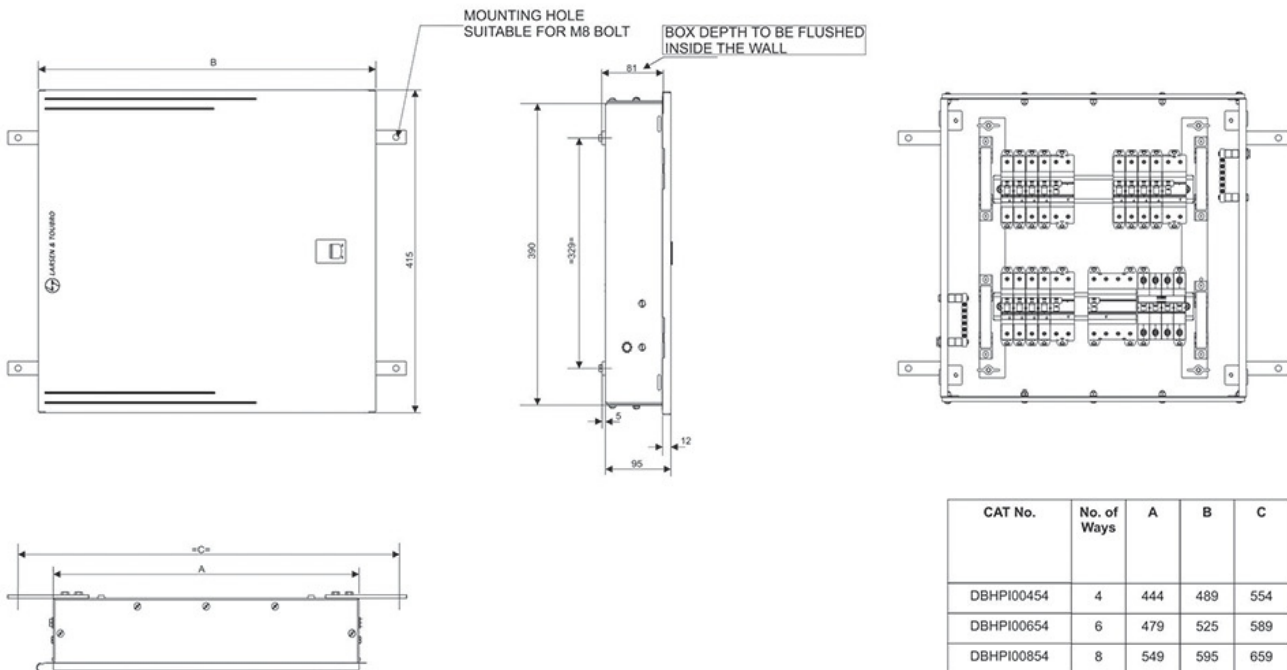

CAT No.	No. of Ways	A	B	C
DBHPI00454	4	444	489	554
DBHPI00654	6	479	525	589
DBHPI00854	8	549	595	659

UNLESS OTHERWISE SPECIFIED DIMENSIONS ARE IN mm
TOLERANCE ON DIMENSIONS = ± 2 mm

Dimension Details Tier PPI DB

IP 43 metal door

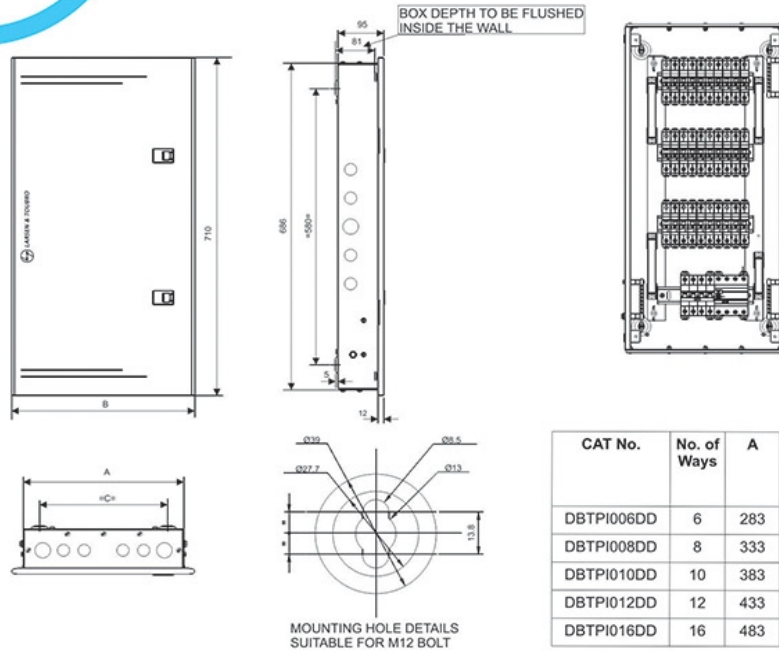

IP 54 metal door

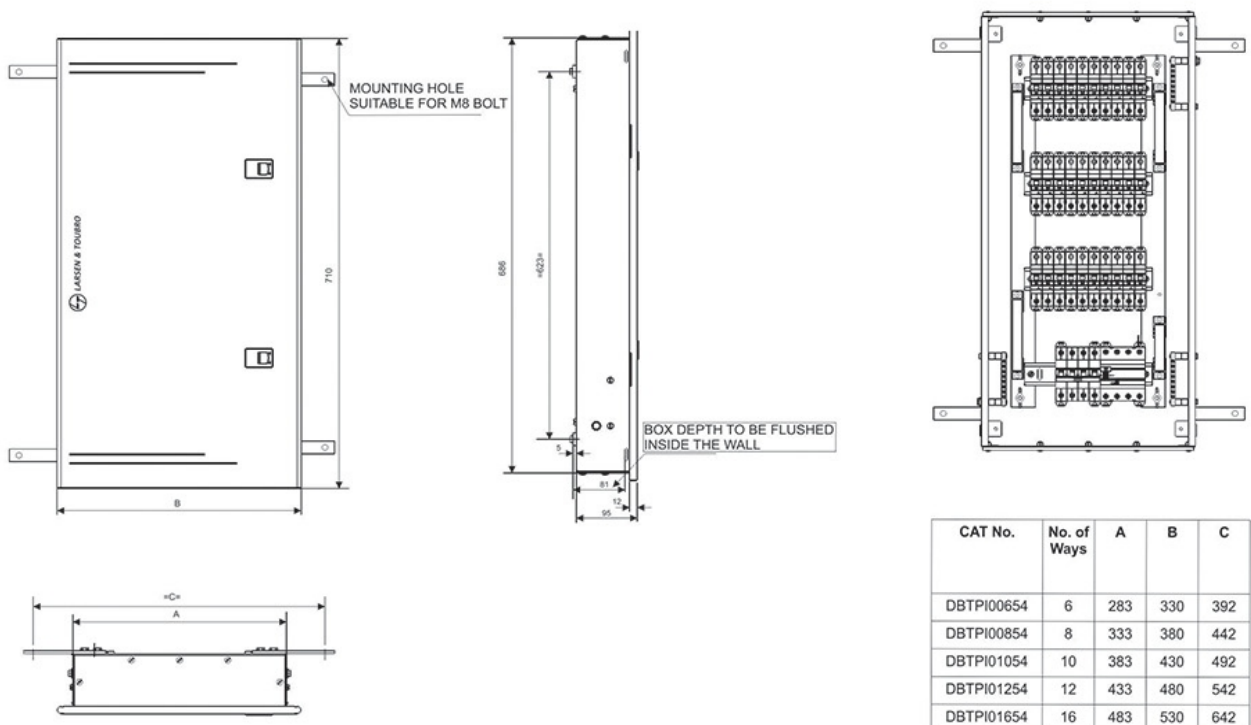

IP 43 metal door - MCCB incomer

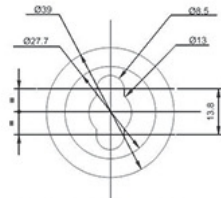
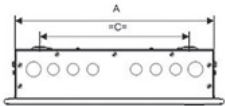
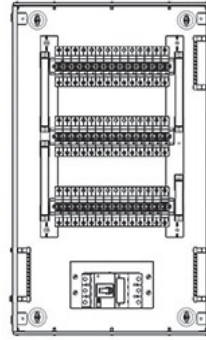
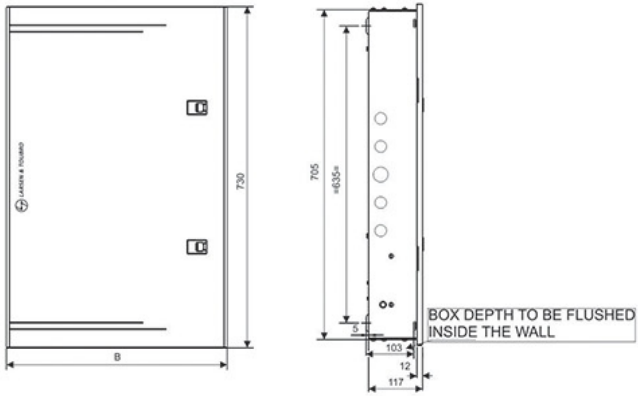

MOUNTING HOLE DETAILS
SUITABLE FOR M12 BOLT

CAT No.	No. of Ways	A	B	C	Top/Bottom Knock out		Side Knock out	
					$\varnothing 32$	$\varnothing 25$	$\varnothing 32$	$\varnothing 25$
DBTPL012DD	12	433	480	325	2	6	1	4

IP 54 metal door - MCCB incomer

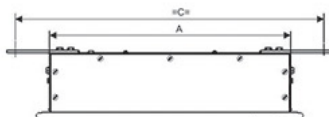
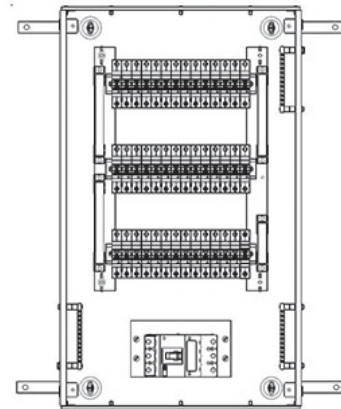
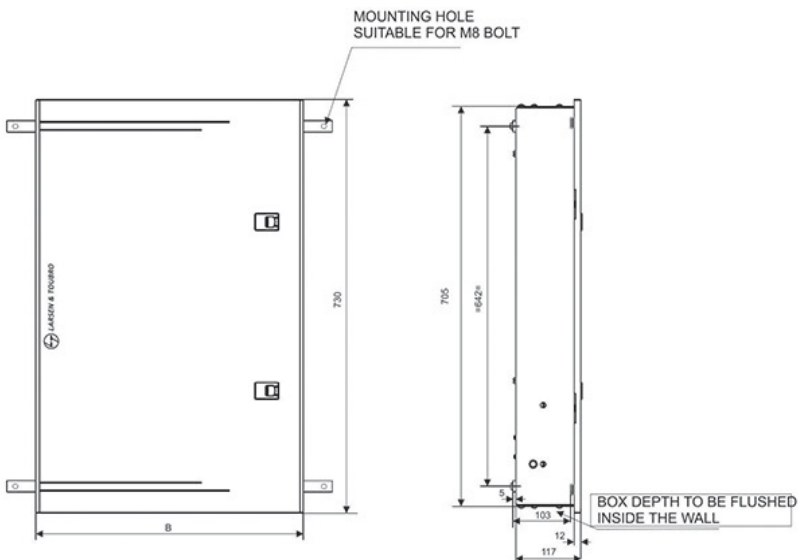

CAT No.	No. of Ways	A	B	C
DBTPL01254	12	433	480	542

UNLESS OTHERWISE SPECIFIED DIMENSIONS ARE IN mm
TOLERANCE ON DIMENSIONS = ± 2 mm

Dimension Details VTPN DB-MCB Incomer

IP 30 metal door

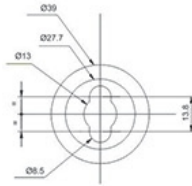
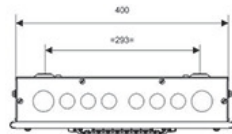
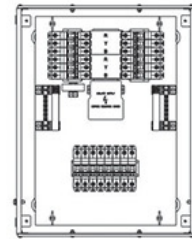
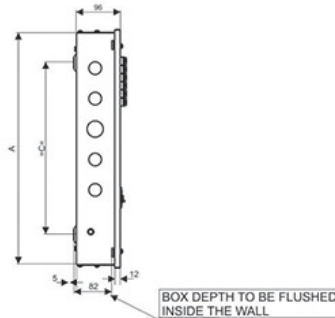
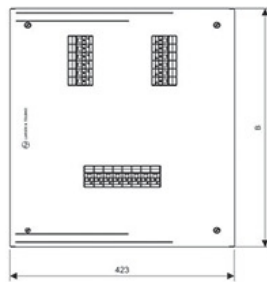

MOUNTING HOLE DETAILS
SUITABLE FOR M12 BOLT

CAT No.	No. of Ways	A	B	C	Top/Bottom Knock out		Side Knock out	
					Ø32	Ø25	Ø32	Ø25
DBVTM004SD	4	505	517	373	2	6	1	4
DBVTM006SD	6	560	572	428	2	6	1	4
DBVTM008SD	8	615	627	483	2	6	1	4
DBVTM012SD	12	755	782	623	2	6	1	4
DBVTM016SD	16	926	953	793	2	6	1	4

IP 43 metal door

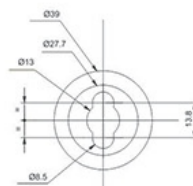
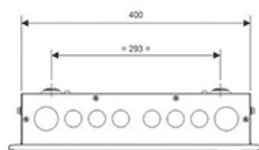
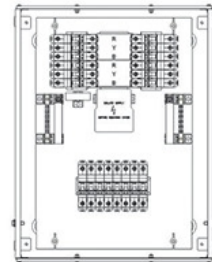
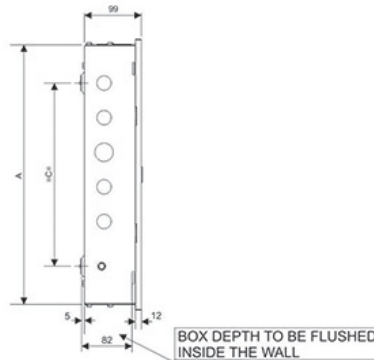
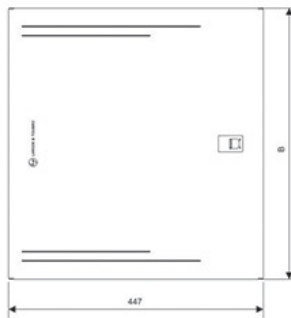

MOUNTING HOLE DETAILS
SUITABLE FOR M12 BOLT

CAT No.	No. of Ways	A	B	C	Top/Bottom Knock out		Side Knock out	
					Ø32	Ø25	Ø32	Ø25
DBVTM004DD	4	509	533	373	2	6	1	4
DBVTM006DD	6	564	588	428	2	6	1	4
DBVTM008DD	8	619	643	483	2	6	1	4
DBVTM012DD	12	759	783	623	2	6	1	4
DBVTM016DD	16	926	954	793	2	6	1	4

IP 43 glazed door

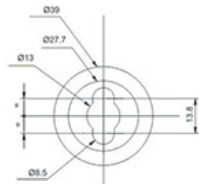
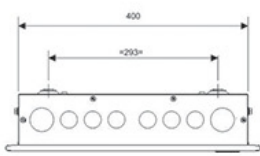
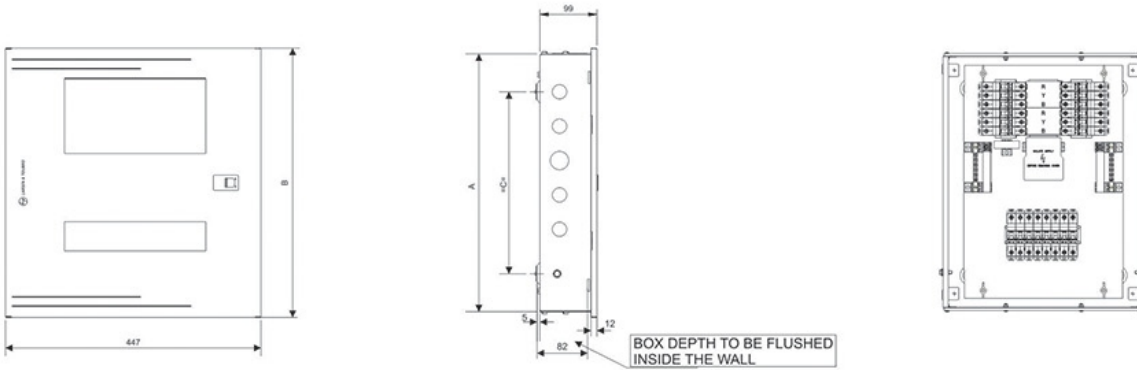

MOUNTING HOLE DETAILS
SUITABLE FOR M12 BOLT

CAT No.	No. of Ways	A	B	C	Top/Bottom Knock out		Side Knock out	
					Ø32	Ø25	Ø32	Ø25
DBVTM004GD	4	509	533	373	2	6	1	4
DBVTM006GD	6	564	588	428	2	6	1	4
DBVTM008GD	8	619	643	483	2	6	1	4
DBVTM012GD	12	759	783	623	2	6	1	4
DBVTM016GD	16	926	954	793	2	6	1	4

IP 54 metal door

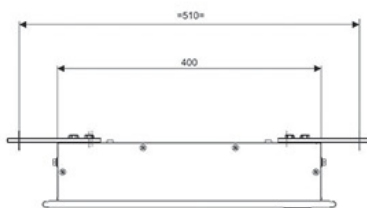
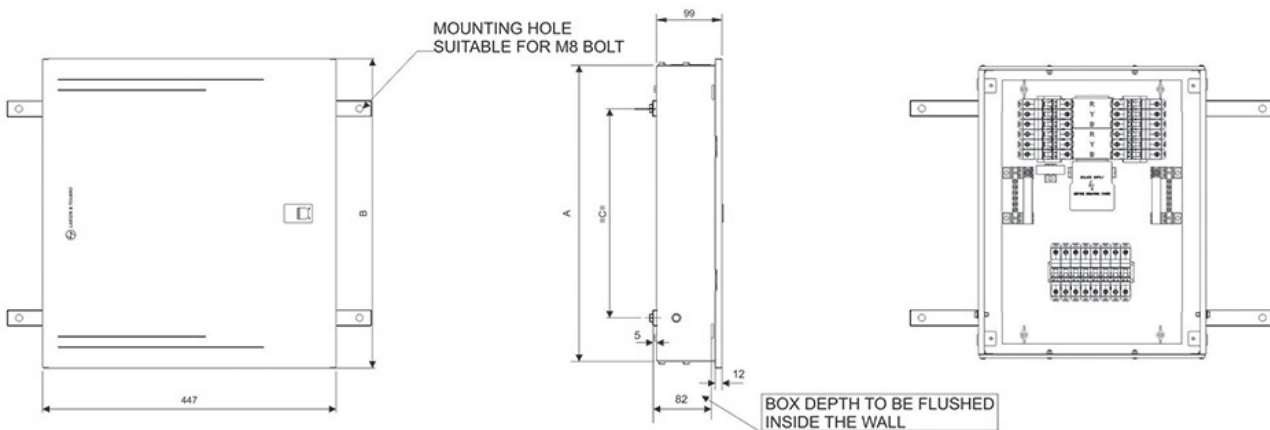

CAT No.	No. of Ways	A	B	C
DBVTM00454	4	509	533	373
DBVTM00654	6	564	588	428
DBVTM00854	8	619	643	483
DBVTM01254	12	759	783	623
DBVTM01654	16	926	954	793

UNLESS OTHERWISE SPECIFIED DIMENSIONS ARE IN mm
TOLERANCE ON DIMENSIONS = ±2 mm

Dimension Details VTPN DB-125A MCCB Incomer

IP 30 metal door

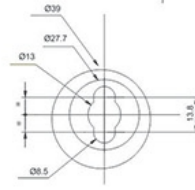
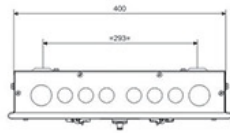
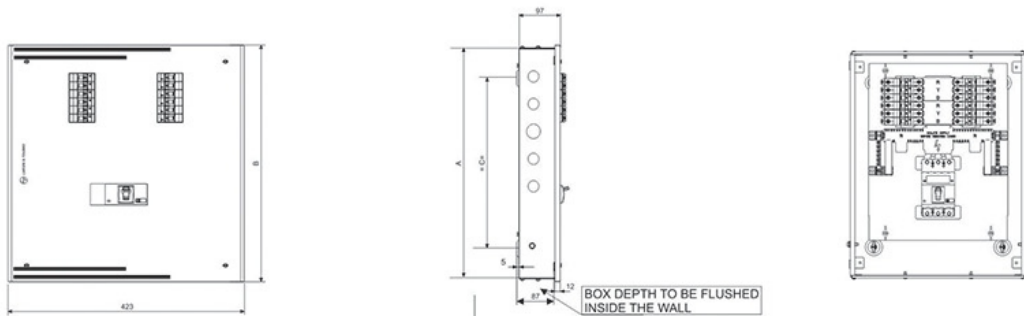

MOUNTING HOLE DETAILS
SUITABLE FOR M12 BOLT

CAT No.	No. of Ways	A	B	C	Top/Bottom Knock out		Side Knock out	
					Ø32	Ø25	Ø32	Ø25
DBVTL004SD	4	505	518	373	2	6	1	4
DBVTL006SD	6	560	573	428	2	6	1	4
DBVTL008SD	8	615	628	483	2	6	1	4
DBVTL012SD	12	725	738	593	2	6	1	4
DBVTL016SD	16	851	863	718	2	6	1	4

IP 43 metal door

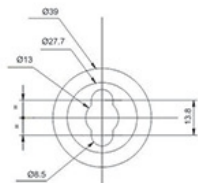
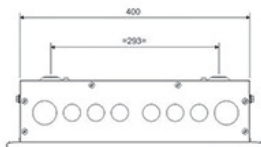
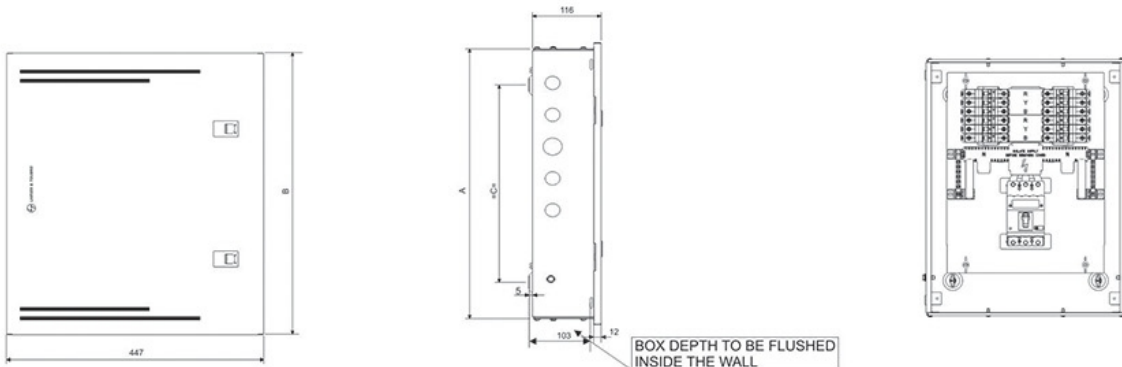

MOUNTING HOLE DETAILS
SUITABLE FOR M12 BOLT

CAT No.	No. of Ways	A	B	C	Top/Bottom Knock out		Side Knock out	
					Ø32	Ø25	Ø32	Ø25
DBVTL004DD	4	509	533	373	2	6	1	4
DBVTL006DD	6	564	588	428	2	6	1	4
DBVTL008DD	8	619	643	483	2	6	1	4
DBVTL012DD	12	729	753	593	2	6	1	4
DBVTL016DD	16	851	879	718	2	6	1	4

IP 43 glazed door

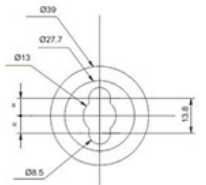
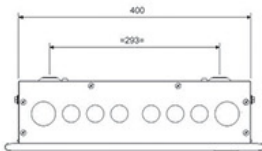
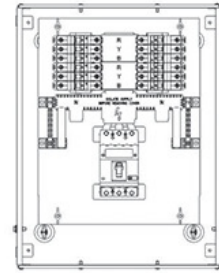
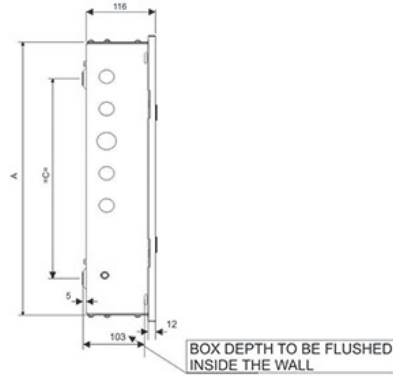
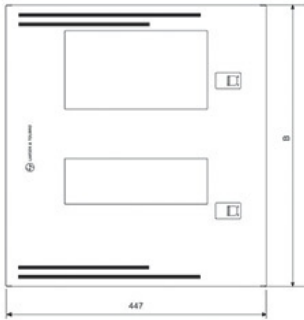

MOUNTING HOLE DETAILS
SUITABLE FOR M12 BOLT

CAT No.	No. of Ways	A	B	C	Top/Bottom Knock out		Side Knock out	
					$\varnothing 32$	$\varnothing 25$	$\varnothing 32$	$\varnothing 25$
DBVTL004GD	4	509	533	373	2	6	1	4
DBVTL006GD	6	564	588	428	2	6	1	4
DBVTL008GD	8	619	643	483	2	6	1	4
DBVTL012GD	12	729	753	593	2	6	1	4
DBVTL016GD	16	851	879	718	2	6	1	4

IP 54 metal door

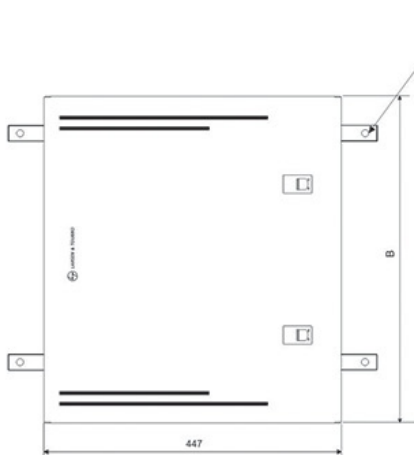

MOUNTING HOLE
SUITABLE FOR M8 BOLT

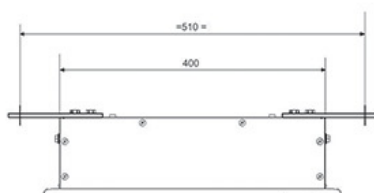
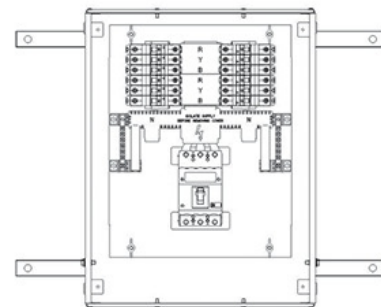
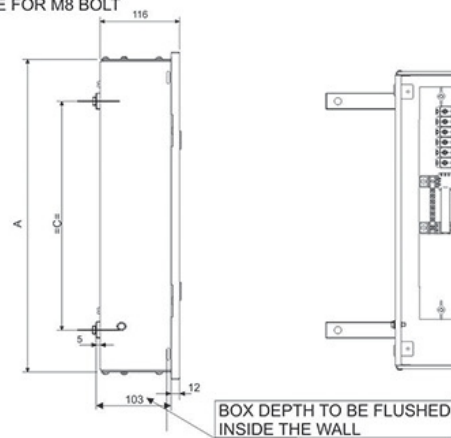

CAT No.	No. of Ways	A	B	C
DBVTL00454	4	509	533	380
DBVTL00654	6	564	588	435
DBVTL00854	8	619	643	490
DBVTL01254	12	729	753	600
DBVTL01654	16	851	879	725

UNLESS OTHERWISE SPECIFIED DIMENSIONS ARE IN mm
TOLERANCE ON DIMENSIONS = ± 2 mm

Dimension Details VTPN DB-250A MCCB Incomer

IP 30 metal door

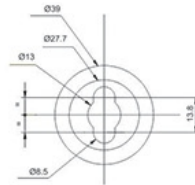
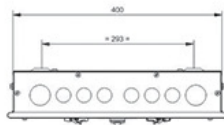
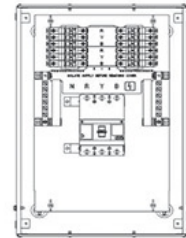
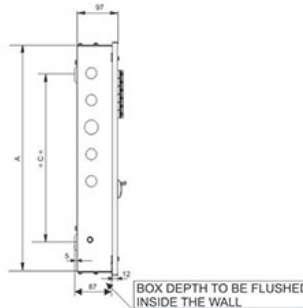
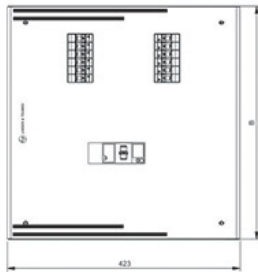

MOUNTING HOLE DETAILS
SUITABLE FOR M12 BOLT

CAT No.	No. of Ways	A	B	C	Top/Bottom Knock out		Side Knock out	
					Ø32	Ø25	Ø32	Ø25
DBVTH004SD	4	615	628	483	2	6	1	4
DBVTH006SD	6	670	683	538	2	6	1	4
DBVTH008SD	8	725	738	593	2	6	1	4
DBVTH012SD	12	851	863	718	2	6	1	4
DBVTH016SD	16	1016	1028	883	2	6	1	4

IP 43 metal door

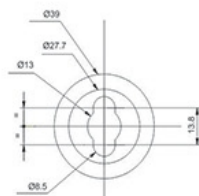
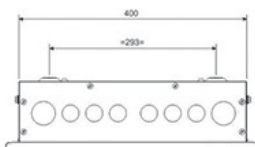
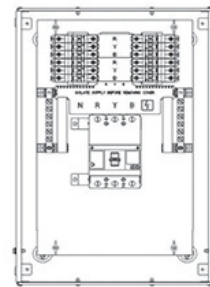
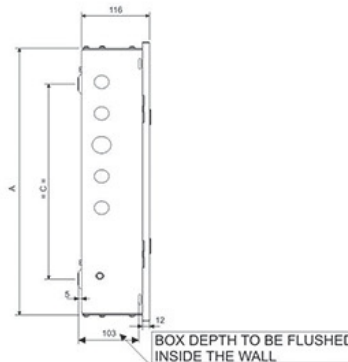
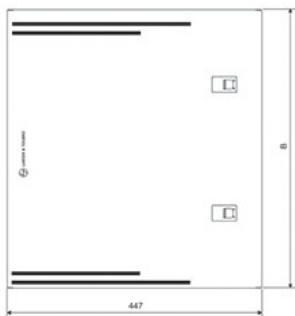

MOUNTING HOLE DETAILS
SUITABLE FOR M12 BOLT

CAT No.	No. of Ways	A	B	C	Top/Bottom Knock out		Side Knock out	
					Ø32	Ø25	Ø32	Ø25
DBVTH004DD	4	615	643	483	2	6	1	4
DBVTH006DD	6	670	698	538	2	6	1	4
DBVTH008DD	8	725	753	593	2	6	1	4
DBVTH012DD	12	851	879	718	2	6	1	4
DBVTH016DD	16	1016	1044	883	2	6	1	4

IP 43 glazed door

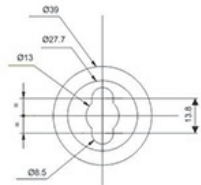
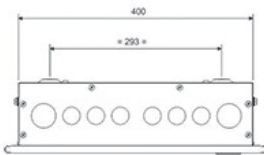
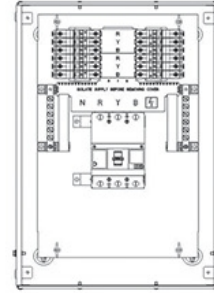
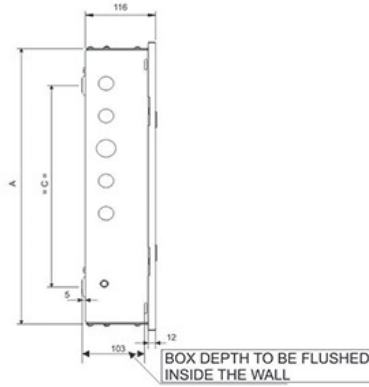
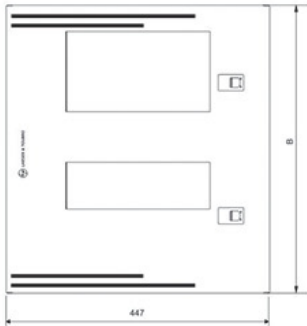

MOUNTING HOLE DETAILS
SUITABLE FOR M12 BOLT

CAT No.	No. of Ways	A	B	C	Top/Bottom Knock out		Side Knock out	
					Ø32	Ø25	Ø32	Ø25
DBVTH004GD	4	615	643	483	2	6	1	4
DBVTH006GD	6	670	698	538	2	6	1	4
DBVTH008GD	8	725	753	593	2	6	1	4
DBVTH012GD	12	851	879	718	2	6	1	4
DBVTH016GD	16	1016	1044	883	2	6	1	4

IP 54 metal door

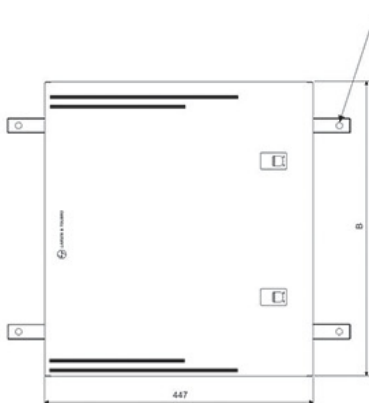

MOUNTING HOLE
SUITABLE FOR M8 BOLT

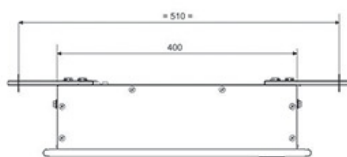
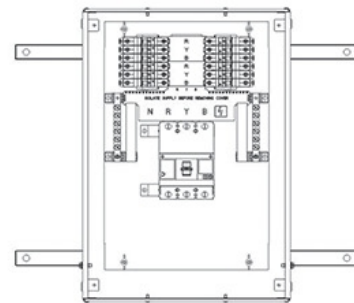
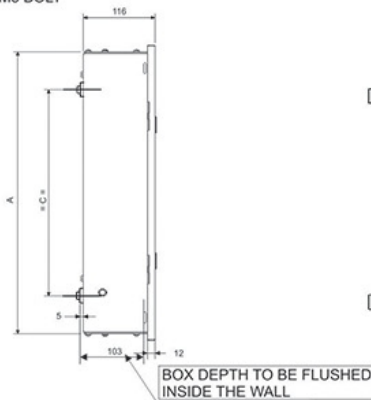

CAT No.	No. of Ways	A	B	C
DBVTH00454	4	615	643	490
DBVTH00654	6	670	698	545
DBVTH00854	8	725	753	600
DBVTH01254	12	851	879	725
DBVTH01654	16	1016	1044	890

UNLESS OTHERWISE SPECIFIED DIMENSIONS ARE IN mm
TOLERANCE ON DIMENSIONS = ± 2 mm

Dimension Details Phase Selector DB

IP 30 metal door

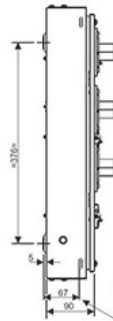
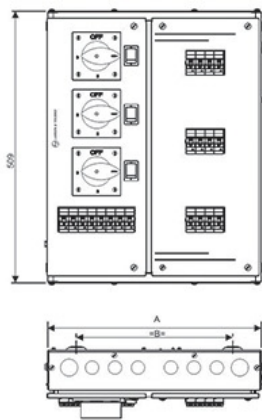

BOX DEPTH TO BE FLUSHED
INSIDE THE WALL

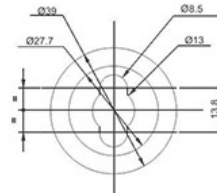
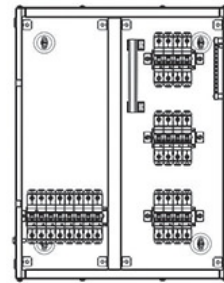

MOUNTING HOLE DETAILS
SUITABLE FOR M12 BOLT

CAT No.	No. of Ways	A	B	Top/Bottom Knock out	
				Ø32	Ø25
DBPSR004SD	4	400	293	2	6
DBPSR006SD	6	435	328	2	6
DBPSR008SD	8	470	363	2	8
DBPSR010SD	10	505	398	2	8
DBPSR012SD	12	540	433	2	10

IP 43 metal door

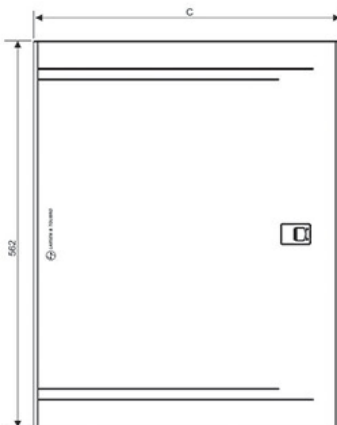

BOX DEPTH TO BE FLUSHED
INSIDE THE WALL

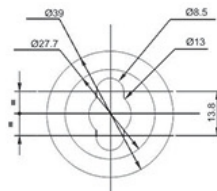
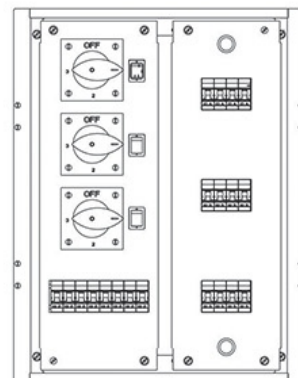

MOUNTING HOLE DETAILS
SUITABLE FOR M12 BOLT

CAT No.	No. of Ways	A	B	C	Top/Bottom Knock out	
					Ø32	Ø25
DBPSR004DD	4	400	294	445	2	6
DBPSR006DD	6	435	329	480	2	6
DBPSR008DD	8	470	364	515	2	8
DBPSR010DD	10	505	399	550	2	8
DBPSR012DD	12	540	434	585	2	10

IP 54 metal door

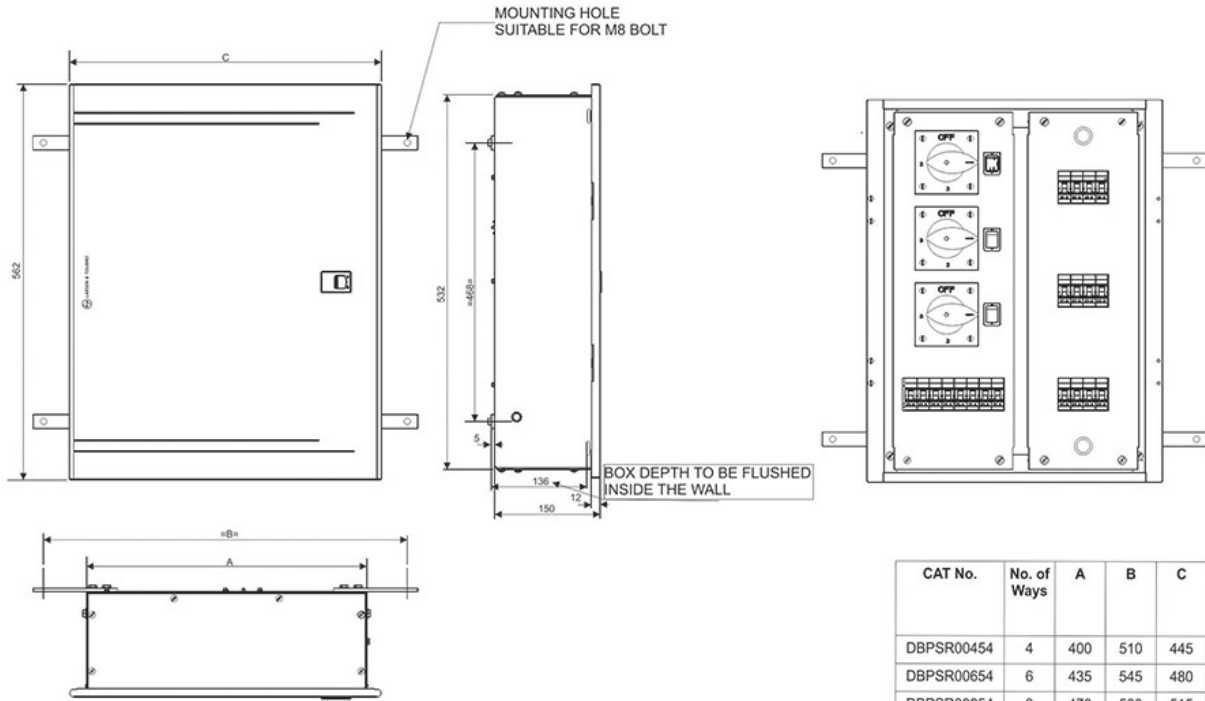

CAT No.	No. of Ways	A	B	C
DBPSR00454	4	400	510	445
DBPSR00654	6	435	545	480
DBPSR00854	8	470	580	515
DBPSR01054	10	505	615	550
DBPSR01254	12	540	650	585

UNLESS OTHERWISE SPECIFIED DIMENSIONS ARE IN mm
TOLERANCE ON DIMENSIONS = ± 2 mm

Dimension Details Phase Segregated DB- MCB incomer

IP 30 metal door

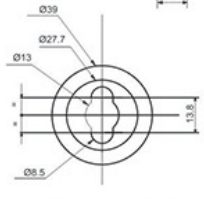
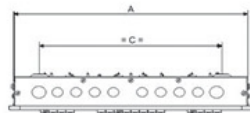
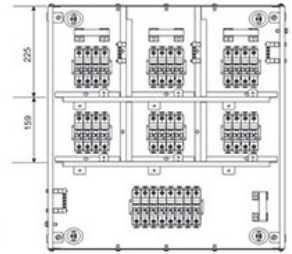
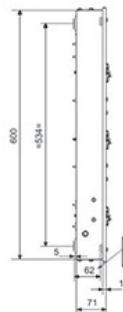
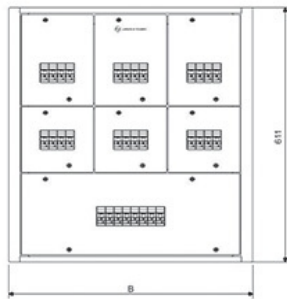

MOUNTING HOLE DETAILS
SUITABLE FOR M12 BOLT

CAT No.	No. of Ways	A	B	C	Top/Bottom Knock out	
					Ø32	Ø25
DBPSG004SD	4	491	513	384	2	8
DBPSG006SD	6	596	618	489	2	10
DBPSG008SD	8	701	723	594	2	12
DBPSG012SD	12	911	933	804	2	18

IP 43 metal door

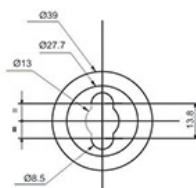
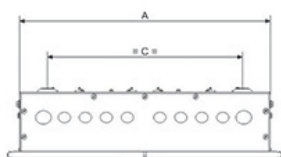
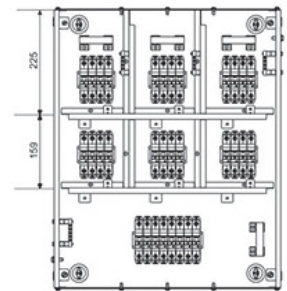
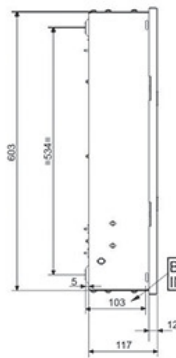
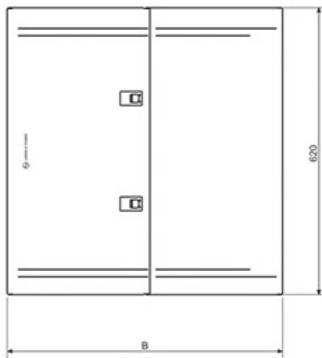

MOUNTING HOLE DETAILS
SUITABLE FOR M12 BOLT

CAT No.	No. of Ways	A	B	C	Top/Bottom Knock out	
					Ø32	Ø25
DBPSG004DD	4	491	540	384	2	8
DBPSG006DD	6	596	646	489	2	10
DBPSG008DD	8	701	751	594	2	12
DBPSG012DD	12	911	961	804	2	18

IP 54 metal door

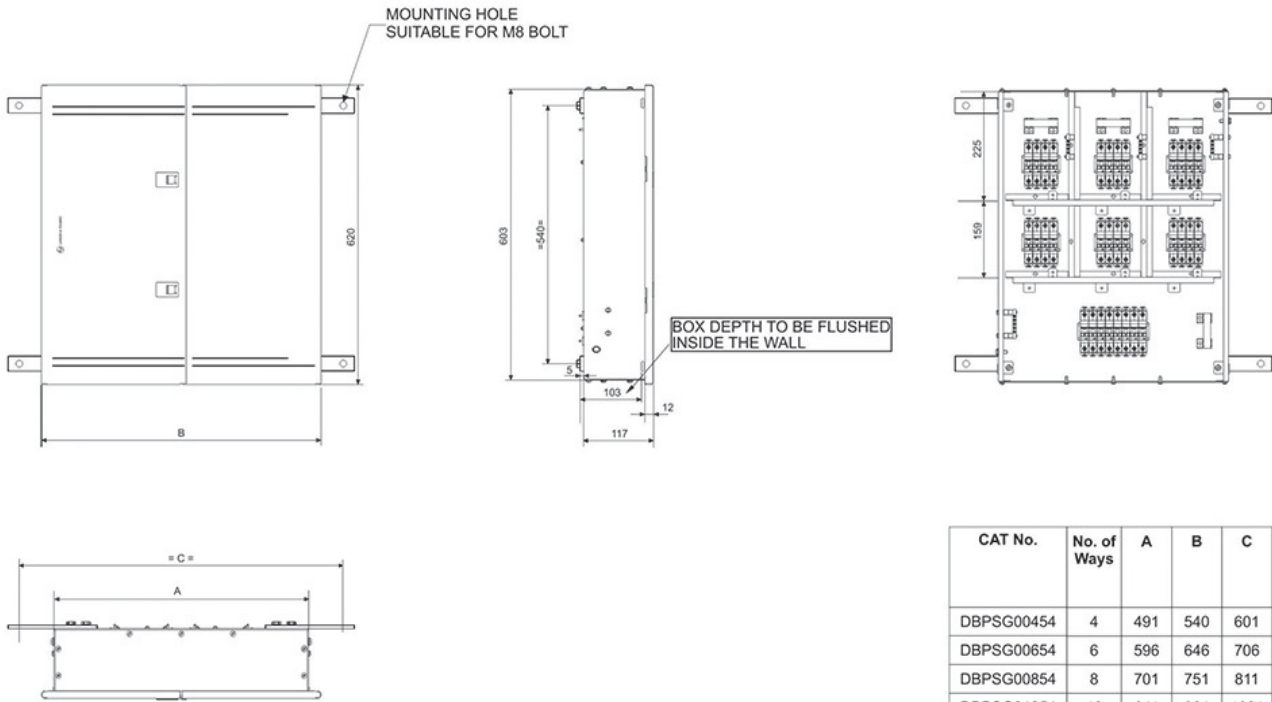

CAT No.	No. of Ways	A	B	C
DBPSG00454	4	491	540	601
DBPSG00654	6	596	646	706
DBPSG00854	8	701	751	811
DBPSG01254	12	911	961	1021

UNLESS OTHERWISE SPECIFIED DIMENSIONS ARE IN mm
TOLERANCE ON DIMENSIONS = ± 2 mm

Dimension Details Phase Segregated DB- MCCB incomer

IP 30 metal door

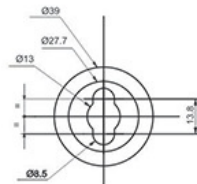
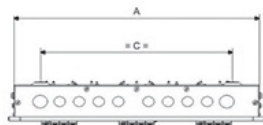
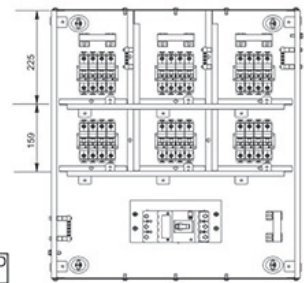
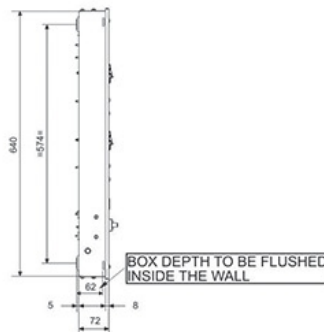
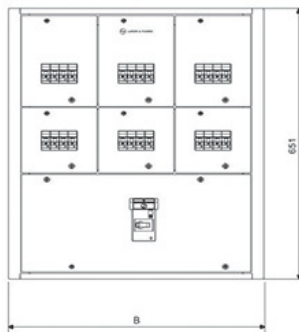

MOUNTING HOLE DETAILS
SUITABLE FOR M12 BOLT

CAT No.	No. of Ways	A	B	C	Top/Bottom Knock out	
					Ø32	Ø25
DBPGL004SD	4	491	513	384	2	8
DBPGL006SD	6	596	618	489	2	10
DBPGL008SD	8	701	723	594	2	12
DBPGL012SD	12	911	933	804	2	18

IP 43 metal door

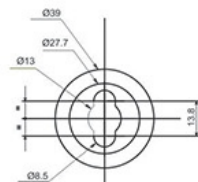
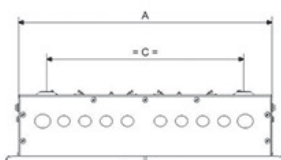
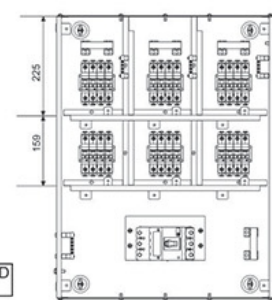
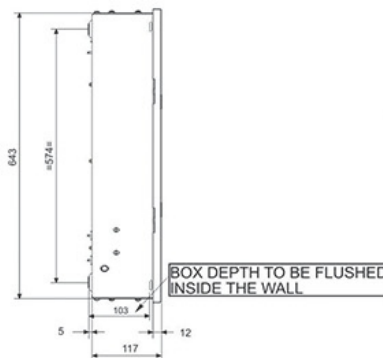

MOUNTING HOLE DETAILS
SUITABLE FOR M12 BOLT

CAT No.	No. of Ways	A	B	C	Top/Bottom Knock out	
					Ø32	Ø25
DBPGL004DD	4	491	541	384	2	8
DBPGL006DD	6	596	646	489	2	10
DBPGL008DD	8	701	751	594	2	12
DBPGL012DD	12	911	961	804	2	18

IP 54 metal door

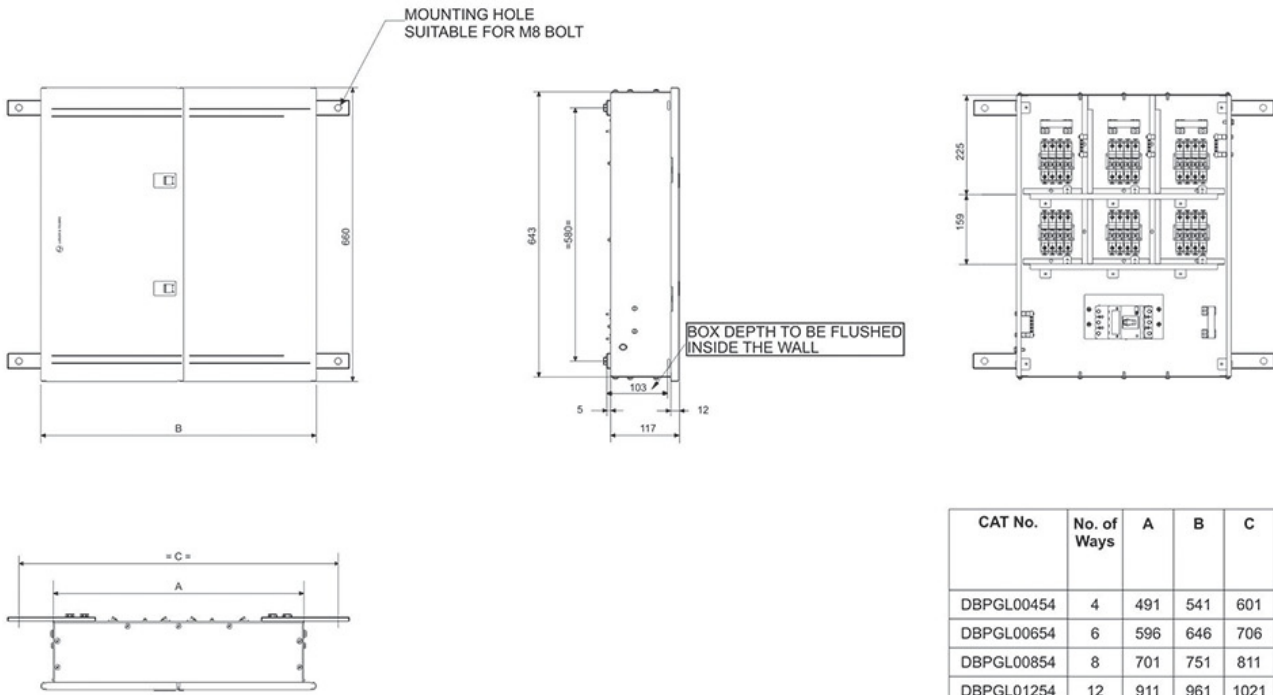

UNLESS OTHERWISE SPECIFIED DIMENSIONS ARE IN mm
TOLERANCE ON DIMENSIONS = ± 2 mm

Dimension Details Flexi / Row DB

IP 30 single door

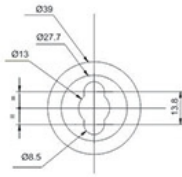
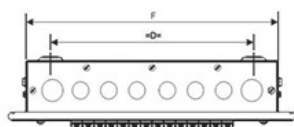
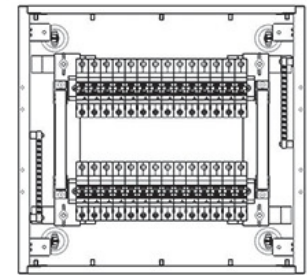
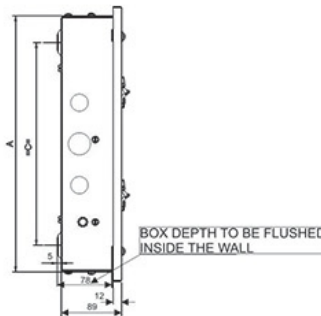
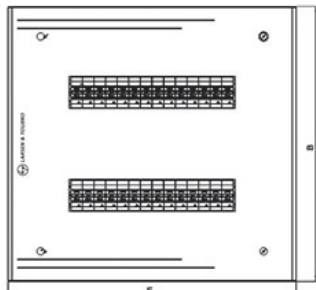

MOUNTING HOLE DETAILS
SUITABLE FOR M12 BOLT

CAT No.	No. of Rows	No. of Mods/ Row	A	B	C	D	E	F	Top/Bottom Knock out		Side Knock out	
									Ø32	Ø25	Ø32	Ø25
DBROW228SD	2	14	372	400	295	310	440	385	2	6	1	2
DBROW342SD	3	14	552	580	475	310	440	385	2	6	1	4
DBROW456SD	4	14	682	710	605	310	440	385	2	6	1	4
DBROW464SD	4	16	682	710	605	350	480	425	2	6	1	4

IP 43 metal door

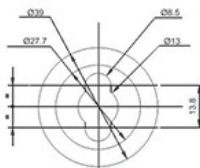
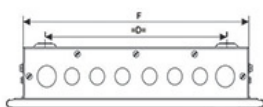
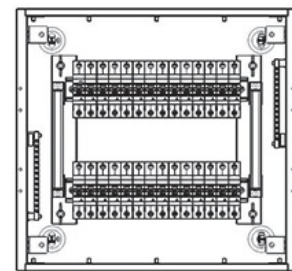
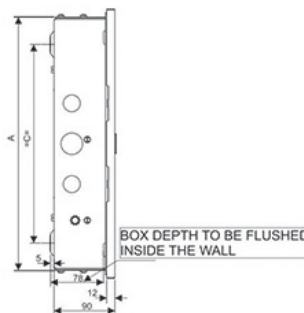
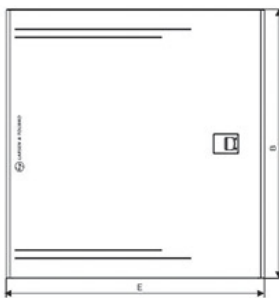

MOUNTING HOLE DETAILS
SUITABLE FOR M12 BOLT

CAT No.	No. of Rows	No. of Mods/ Row	A	B	C	D	E	F	Top/Bottom Knock out		Side Knock out	
									Ø32	Ø25	Ø32	Ø25
DBROW228DD	2	14	376	400	295	310	440	385	2	6	1	2
DBROW342DD	3	14	556	580	475	310	440	385	2	6	1	4
DBROW456DD	4	14	686	710	605	310	440	385	2	6	1	4
DBROW464DD	4	16	686	710	605	350	480	425	2	6	1	4

IP 43 glazed door

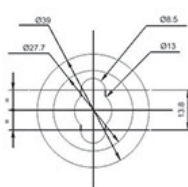
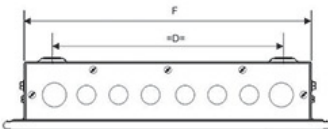
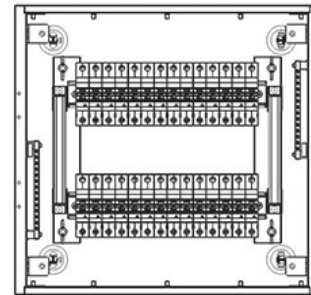
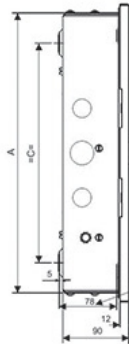
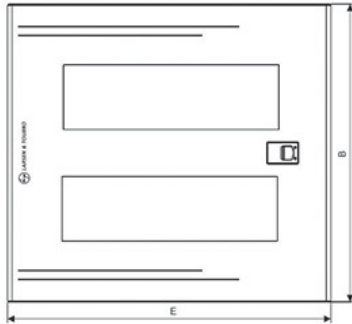

CAT No.	No. of Rows	No. of Mods/ Row	A	B	C	D	E	F	Top/Bottom Knock out		Side Knock out	
									Ø32	Ø25	Ø32	Ø25
DBROW228GD	2	14	376	400	295	310	440	385	2	6	1	2
DBROW342GD	3	14	556	580	475	310	440	385	2	6	1	4
DBROW456GD	4	14	686	710	605	310	440	385	2	6	1	4
DBROW464GD	4	16	686	710	605	350	480	425	2	6	1	4

IP 54 metal door

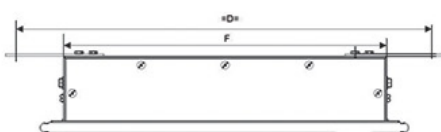
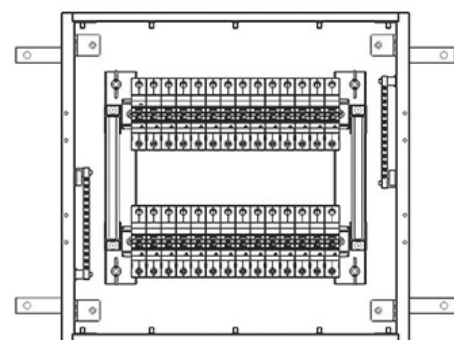
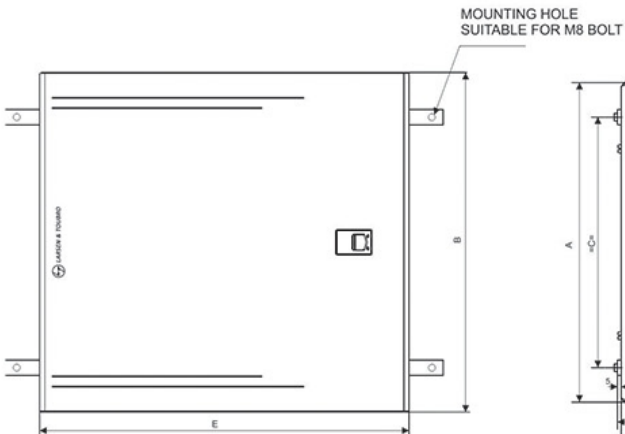

CAT No.	No. of Rows	No. of Mods/ Row	A	B	C	D	E	F
DBROW22854	2	14	376	400	295	494	440	385
DBROW34254	3	14	556	580	493	494	440	385
DBROW45654	4	14	686	710	623	494	440	385
DBROW46454	4	16	686	710	623	534	480	425

UNLESS OTHERWISE SPECIFIED DIMENSIONS ARE IN mm
TOLERANCE ON DIMENSIONS = ±2 mm

Dimension Details Metal Plug & Socket DB

Metal Plug & Socket DB

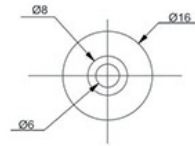
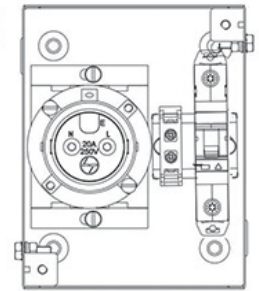
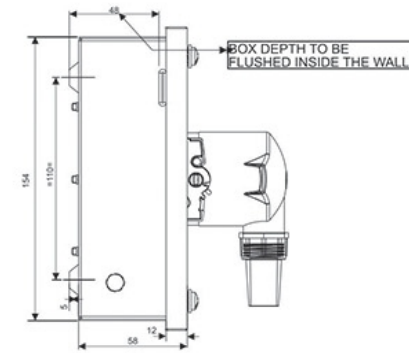
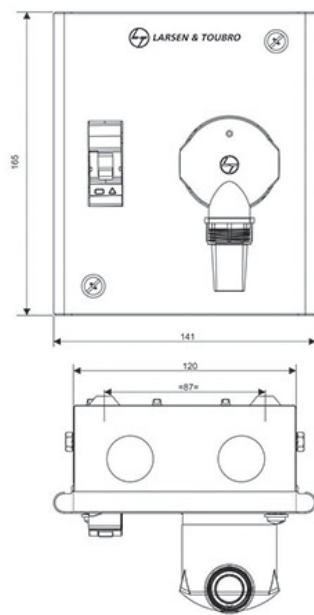

MOUNTING HOLE DETAILS
SUITABLE FOR M5 BOLT

CAT No.	Description	Top/Bottom Knock out
		Ø25
DBMPS110SD	10A, 2Pin+SC - 1MOD	2
DBMPS120SD	20A, 2Pin+SC - 1MOD	2
DBMPS220SD	20A, 2Pin+SC - 2MOD	2

SC - Scraping Earth

Metal Plug & Socket DB

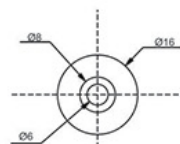
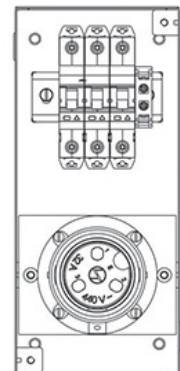
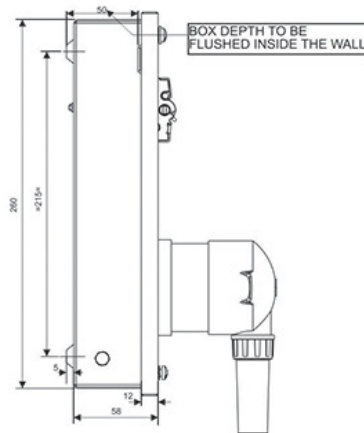
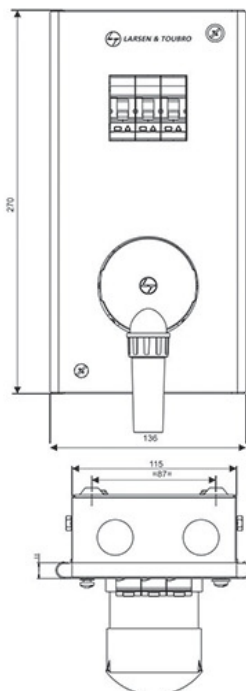

MOUNTING HOLE DETAILS
SUITABLE FOR M5 BOLT

CAT No.	Description	Top/Bottom Knock out
		Ø25
DBMPS320SD	20A, 3Pin+SC - 3MOD	2
DBMPS332SD	32A, 3Pin+SC - 3MOD	2
DBMPS432SD	32A, 3Pin+SC - 4MOD	2

SC - Scraping Earth

Metal Plug & Socket DB

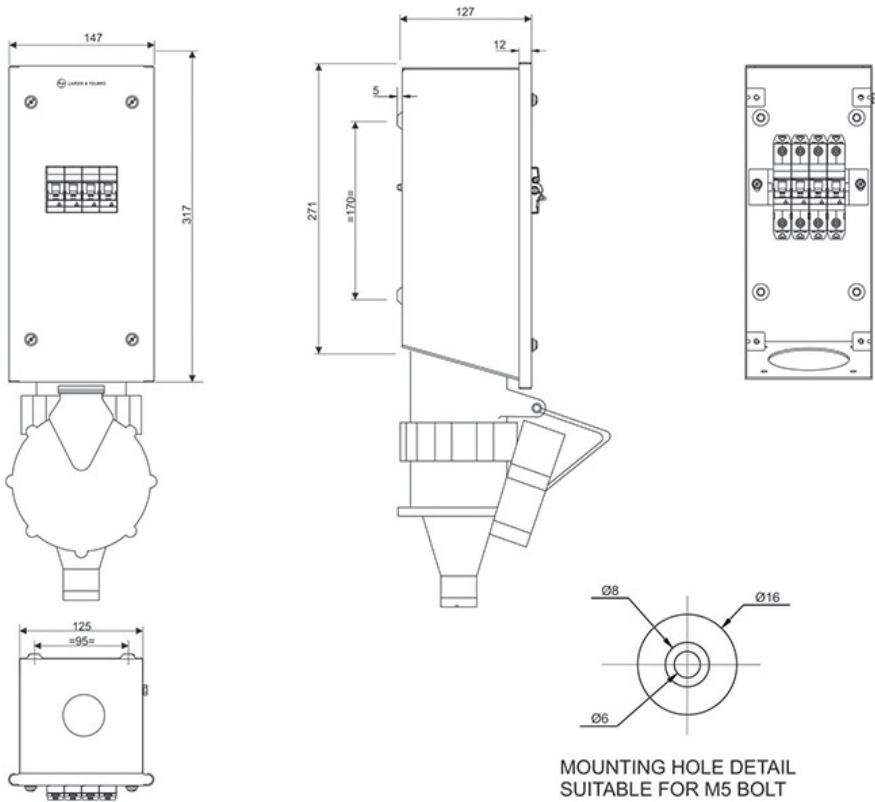

MOUNTING HOLE DETAIL
SUITABLE FOR M5 BOLT

CAT No.	Description	Top/Bottom Knock out
		Ø25
DBMPS463SD	63A, 5Pin+SC - 4MOD	1

SC - Scraping Earth

Dimension Details Plastic Plug & Socket DB

Plastic Plug & Socket DB

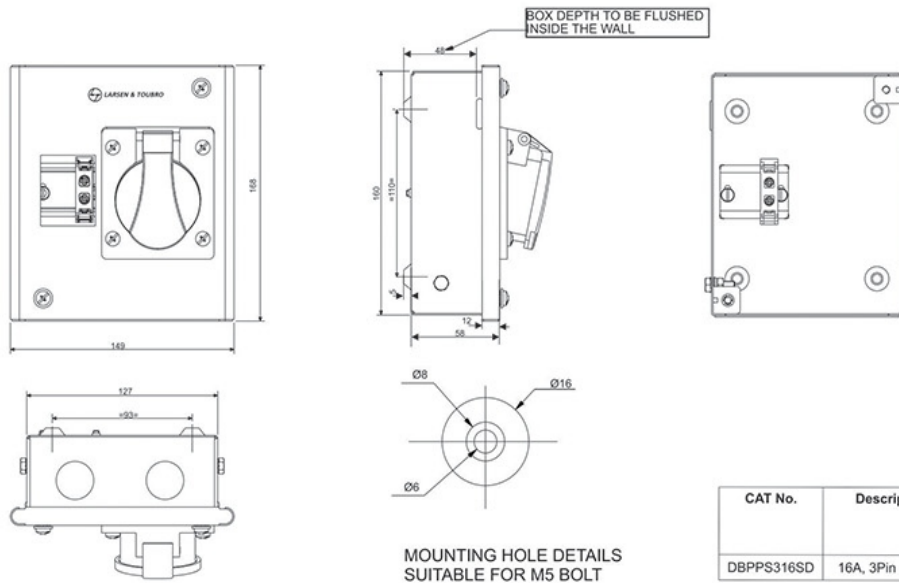

Plastic Plug & Socket DB

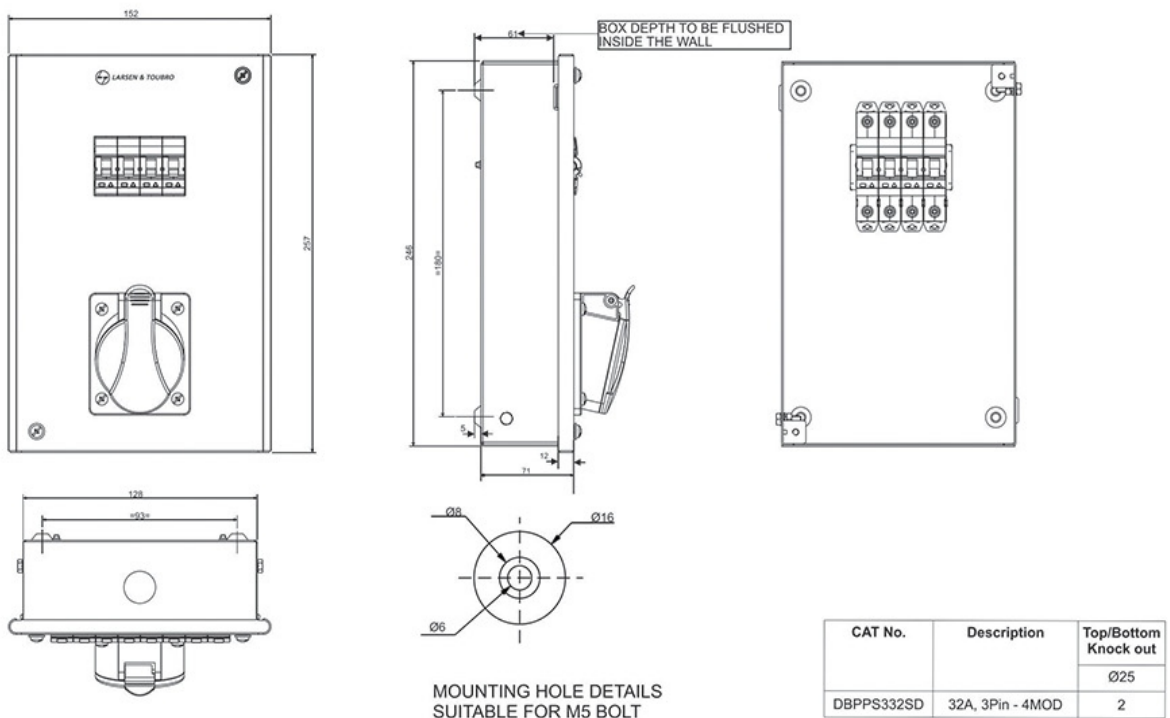

Plastic Plug & Socket DB

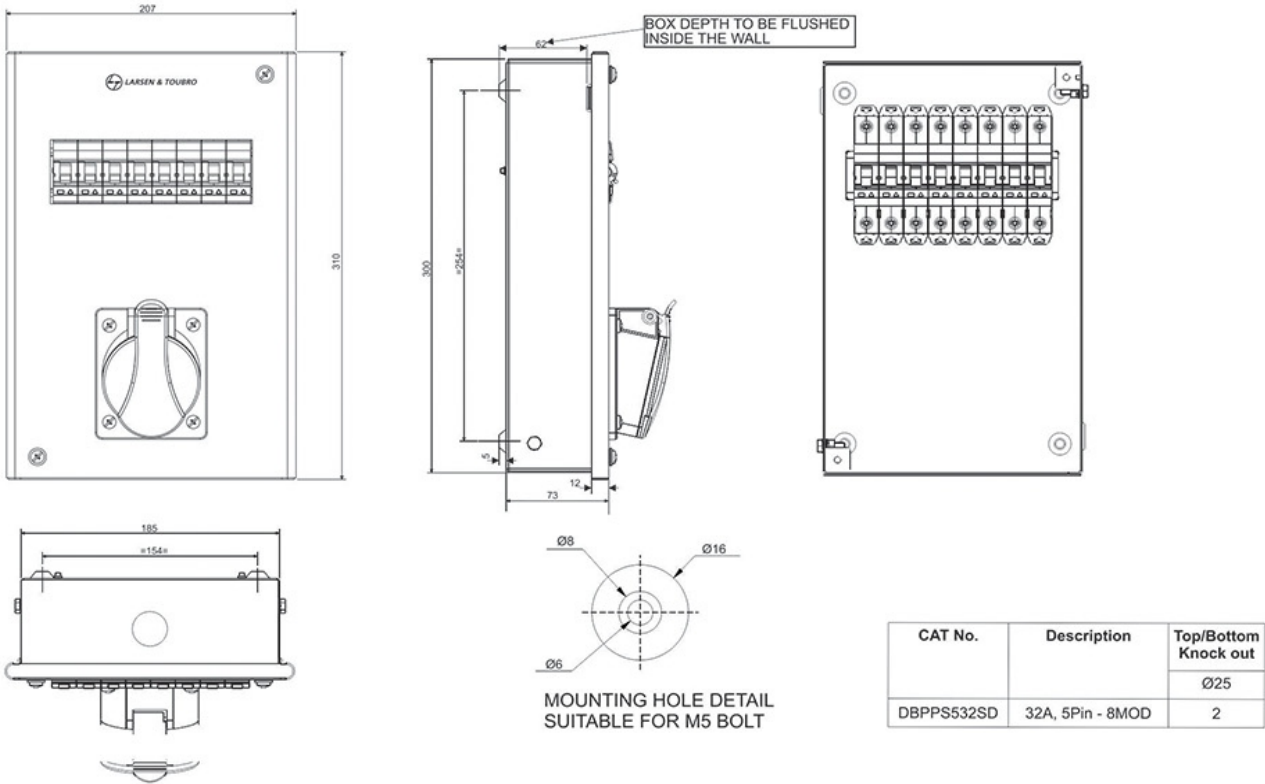

Plastic Plug & Socket DB

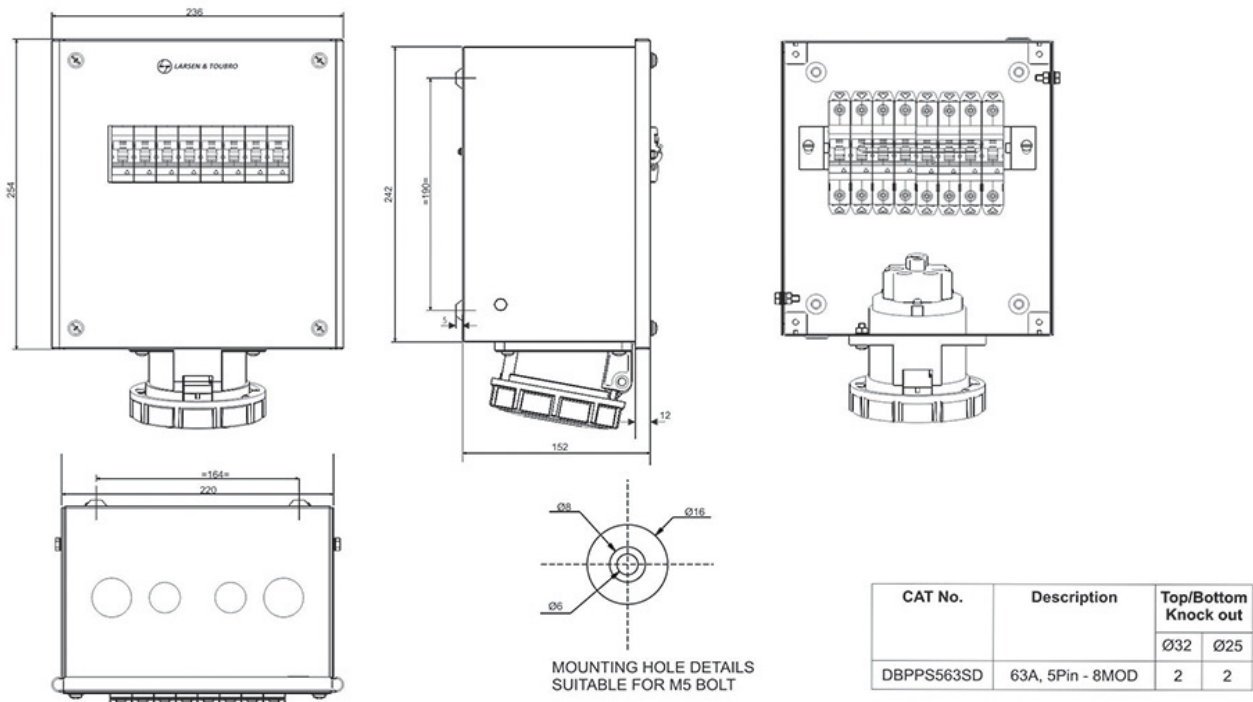

UNLESS OTHERWISE SPECIFIED DIMENSIONS ARE IN mm
TOLERANCE ON DIMENSIONS = ±2 mm

Dimension Details Cable end box

Cable end box

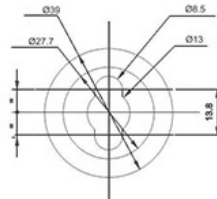
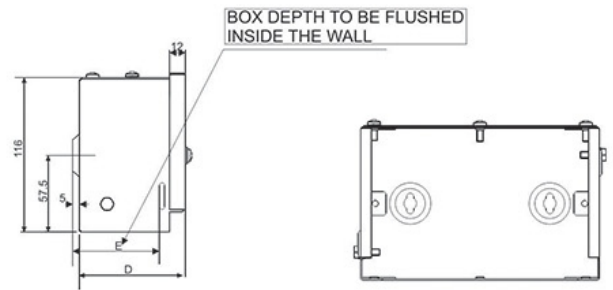
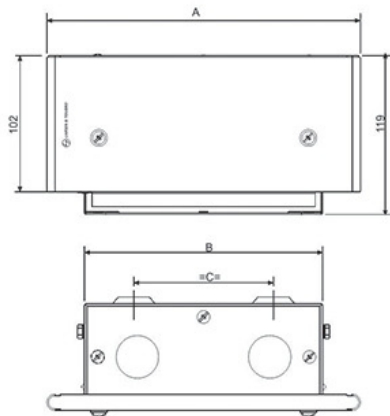

MOUNTING HOLE DETAILS
SUITABLE FOR M12 BOLT

CAT No.	No. of Ways	A	B	C	D	E	Top/Bottom Knock out	
							Ø32	Ø25
DBTPE004CB	4	371	317	252	87	72	2	4
DBTPE006CB	6	411	357	292	87	72	2	4
DBTPN004CB	4	411	357	292	87	72	2	4
DBTPN006CB	6	451	397	332	87	72	2	6
DBTPN008CB	8	516	462	387	87	72	2	8
DBTPN012CB	12	706	652	583	87	72	2	12
DBTPN016CB	16	845	792	725	87	72	2	14
DBHPI004CB	4	489	443	382	90	75	2	6
DBHPI006CB	6	524	478	417	90	75	2	8
DBHPI008CB	8	594	548	487	90	75	2	9
DBHPI012CB	12	769	722	655	90	75	2	14
DBHPI016CB	16	914	867	800	90	75	2	18
DBTPI006CB	6	329	282	215	90	75	2	2
DBTPI008CB	8	379	332	265	90	75	2	4
DBTPI010CB	10	429	382	315	90	75	2	6
DBTPI012CB	12	479	432	365	90	75	2	6
DBTPI016CB	16	579	532	465	90	75	2	8
DBTPL012CB	12	479	432	325	112	97	2	6
DBROWX14CB	14	439	384	310	87	72	2	6
DBROWX16CB	16	479	424	350	87	72	2	6
DBPSG004CB	4	535	491	384	112	97	2	8
DBPSG006CB	6	640	596	489	112	97	2	10
DBPSG008CB	8	745	701	594	112	97	2	12
DBPSG012CB	12	955	911	804	112	97	2	18
DBPSR004CB	4	444	400	294	146	131	2	6
DBPSR006CB	6	479	435	329	146	131	2	6
DBPSR008CB	8	514	470	364	146	131	2	8
DBPSR010CB	10	549	505	399	146	131	2	8
DBPSR012CB	12	584	540	434	146	131	2	10

Cable end box

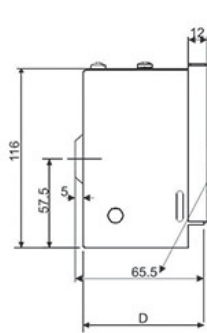
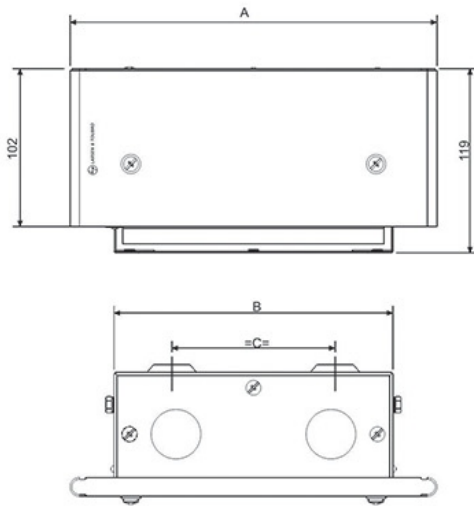

BOX DEPTH TO BE FLUSHED
INSIDE THE WALL

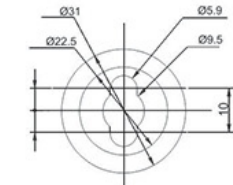
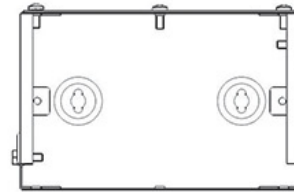

MOUNTING HOLE DETAILS
SUITABLE FOR M8 BOLT

CAT No.	No. of Ways	A	B	C	D	Top/Bottom Knock out	
						Ø32	Ø25
DBSPN004CB	4	236	180	105	80	2	0
DBSPN006CB	6	271	215	140	80	2	2
DBSPN008CB	8	306	250	175	80	2	2
DBSPN012CB	12	376	285	210	80	2	4
DBSPN016CB	16	446	355	280	80	2	6
DBSPN018CB	18	481	390	315	80	2	6

Cable end box

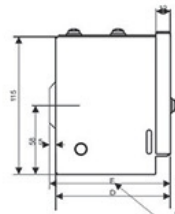
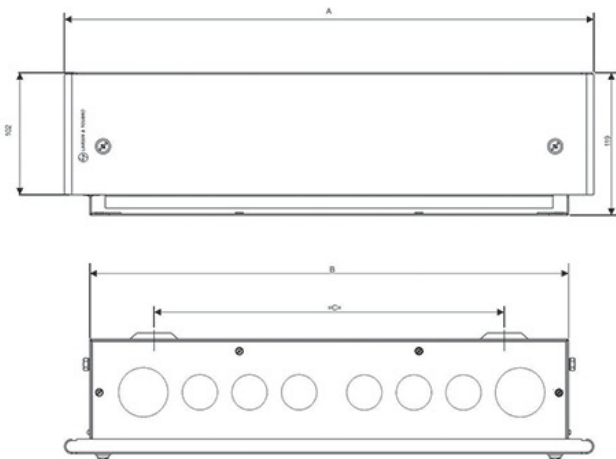

BOX DEPTH TO BE FLUSHED
INSIDE THE WALL

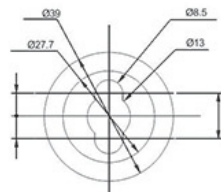

MOUNTING HOLE DETAILS
SUITABLE FOR M12 BOLT

CAT No.	No. of Ways	A	B	C	D	E	Top/Bottom Knock out	
							Ø32	Ø25
DBVTMXXCB	-	441	400	293	95	81	2	6
DBVTXXXCB	-	446	400	293	110	97	2	6

UNLESS OTHERWISE SPECIFIED DIMENSIONS ARE IN mm
TOLERANCE ON DIMENSIONS = ±2 mm

Dimension Details Enclosures

Enclosures

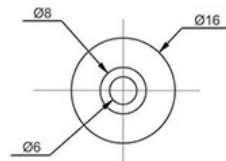
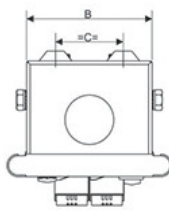
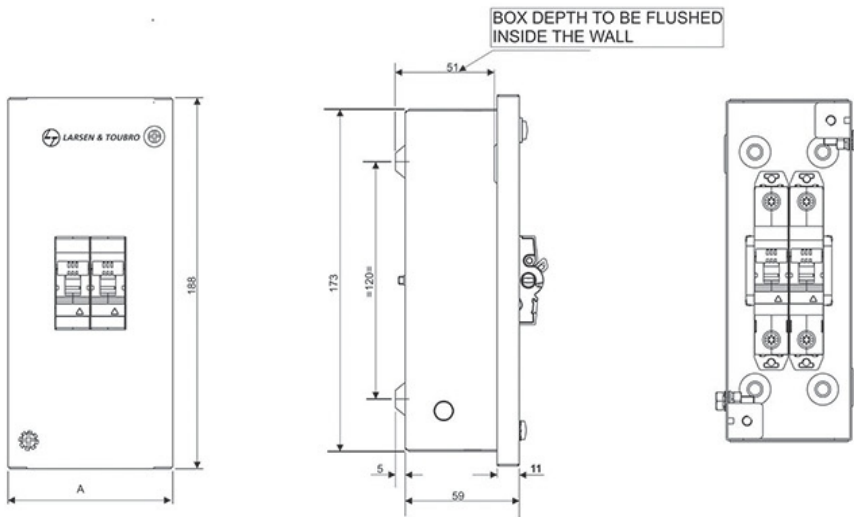

MOUNTING HOLE DETAILS
SUITABLE FOR M5 BOLT

CAT No.	No. of Ways	A	B	C	Top/Bottom Knock out
					Ø25
DBENC002SD	2	85	65	35	1
DBENC003SD	3	95	75	45	1
DBENC004SD	4	105	85	55	1
DBENC006SD	6	145	125	95	2

UNLESS OTHERWISE SPECIFIED DIMENSIONS ARE IN mm
TOLERANCE ON DIMENSIONS = ±2 mm

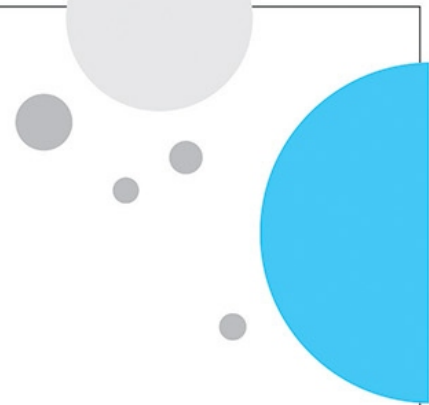

Notes

Electrical Standard Products (ESP) Branch Offices:

REGISTERED OFFICE AND HEAD OFFICE

L&T House, Ballard Estate
P. O. Box 278
Mumbai 400 001
Tel: 022-67525656
Fax: 022-67525858
Website: www.Larsentoubro.com

ELECTRICAL STANDARD PRODUCTS (ESP)

501, Sakar Complex I
Opp. Gandhigram Rly. Station
Ashram Road
Ahmedabad 380 009
Tel: 079-66304006-11
Fax: 079-66304025
e-mail: esp-ahm@LNTEBG.com

38, Cubbon Road, P. O. Box 5098
Bangalore 560 001
Tel: 080-25020100 / 25020324
Fax: 080-25580525
e-mail: esp-blr@LNTEBG.com

131/1, Zone II
Maharana Pratap Nagar
Bhopal 462 011
Tel: 0755-3080511 / 05 / 08 / 13 / 17 / 19
Fax: 0755-3080502
e-mail: esp-bho@LNTEBG.com

Plot No. 559, Annapurna Complex
Lewis Road
Bhubaneswar 751 014
Tel: 0674-6451342, 2436690, 2436696
Fax: 0674-2537309
e-mail: nayakd@LNTEBG.com

SCO 32, Sector 26-D
Madhya Marg, P. O. Box 14
Chandigarh 160 019
Tel: 0172-4646840, 4646853
Fax: 0172-4646802
e-mail: esp-chd@LNTEBG.com

L&T Construction Campus
TC-1 Building, II Floor
Mount-Poonamallee Road
Manapakkam
Chennai 600 089
Tel: 044-2270 6800
Fax: 044-22706840
e-mail: esp-maa1@LNTEBG.com

67, Appuswamy Road
Post Bag 7156
Opp. Nirmala College
Coimbatore 641 045
Tel: 0422-2588120 / 1 / 5
Fax: 0422-2588148
e-mail: esp-cbe@LNTEBG.com

Khairasol, Degaul Avenue
Durgapur 713 212
Tel: 2559848, 2559849, 2559844
Fax: 0343-2553614
e-mail: esp-dgp@LNTEBG.com

5, Milanpur Road, Bamuni Maidan
Guwahati 781 021
Tel: +91 8876554410 / 8876554417
Fax: 361-2551308
e-mail: hazrasudipto@LNTEBG.com

II Floor, Vasantha Chambers
5-10-173, Fateh Maidan Road
Hyderabad 500 004
Tel: 040-67015052
Fax: 040-23296468
e-mail: esp-hyd@LNTEBG.com

Monarch Building, 1st Floor
D-236 & 237, Amrapali Marg
Vaishali Nagar
Jaipur 302 021
Tel: 0141-4385914 to 18
Fax: 0141-4385925
e-mail: esp-jai@LNTEBG.com

Akashdeep Plaza, 2nd Floor
P. O. Golmuri
Jamshedpur 831 003
Jharkhand
Tel: 0657-2312205 / 38
Fax: 0657-2341250
e-mail: esp-jam@LNTEBG.com

Skybright Bldg; M. G. Road
Ravipuram Junction, Ernakulam
Kochi 682 016
Tel: 0484-4409420 / 4 / 5 / 7
Fax: 0484-4409426
e-mail: esp-cok@LNTEBG.com

3-B, Shakespeare Sarani
Kolkata 700 071
Tel: 033-44002572 / 3 / 4
Fax: 033-22821025 / 7587
e-mail: esp-ccu@LNTEBG.com

A28, Indira Nagar, Faizabad Road
Lucknow 226 016
Tel: 0522-4929905 / 04
Fax: 0522-2311671
e-mail: esp-Lko@LNTEBG.com

No: 73, Karpaga Nagar, 8th Street
K. Pudur
Madurai 625 007
Tel: 0452-2537404, 2521068
Fax: 0452-2537552
e-mail: esp-mdu@LNTEBG.com

L&T Business Park
Tower B, 5th Floor
Saki Vihar Road, Powai
Mumbai - 400 072
Tel: 022-67052874 / 2737 / 1156
Fax: 022-67051112
Email: esp-bom@Lntebg.com

12, Shivaji Nagar
North Ambajhari Road
Nagpur 440 010
Tel: 0712-2260012 / 6606421
Fax: 2260030 / 6606434
e-mail: esp-nag@LNTEBG.com

32, Shivaji Marg
P. O. Box 6223
New Delhi 110 015
Tel: 011-41419514 / 5 / 6
Fax: 011-41419600
e-mail: esp-del@LNTEBG.com

L&T House
P. O. Box 119
191/1, Dhole Patil Road
Pune 411 001
Tel: 020-66033395 / 66033279
Fax: 020-26164048 / 26164910
e-mail: esp-pnq@LNTEBG.com

Crystal Tower,
4th Floor, G. E. Road
Telibandha
Raipur - 492 006
Tel: 0771-4283214
e-mail: esp-raipur@LNTEBG.com

3rd Floor
Vishwakarma Chambers
Majura Gate, Ring Road
Surat 395 002
Tel: 0261-2473726
Fax: 0261-2477078
e-mail: esp-sur@LNTEBG.com

Radhadaya Complex
Old Padra Road
Near Charotar Society
Vadodara 390 007
Tel: 0265-6613610 / 1 / 2
Fax: 0265-2336184
e-mail: esp-bar@LNTEBG.com

Door No. 49-38 - 14/3/2, 1st floor,
NGGO's Colony, Akkayyapalem,
Visakhapatnam - 530 016
Tel: 0891 279 1126, 271 1125
Fax: 0891 2791100
e-mail: esp-viz@LNTEBG.com

Product improvement is a continuous process. For the latest information and special applications, please contact any of our offices listed here
Product photographs shown are for representative purpose only.



Larsen & Toubro Limited Electrical Standard Products
Powai Campus, Mumbai 400 072
Customer Interaction Center (CIC)
BSNL / MTNL (toll free) : 1800 233 5858
Reliance (toll free) : 1800 200 5858
Tel : 022 6774 5858, Fax : 022 6774 5859
E-mail : cic@LNTEBG.com Website : www.LNTEBG.com

Registered Office: L&T House, N. M. Marg, Ballard Estate, Mumbai 400 001, INDIA

SP 50672